

CATJ

May
1974

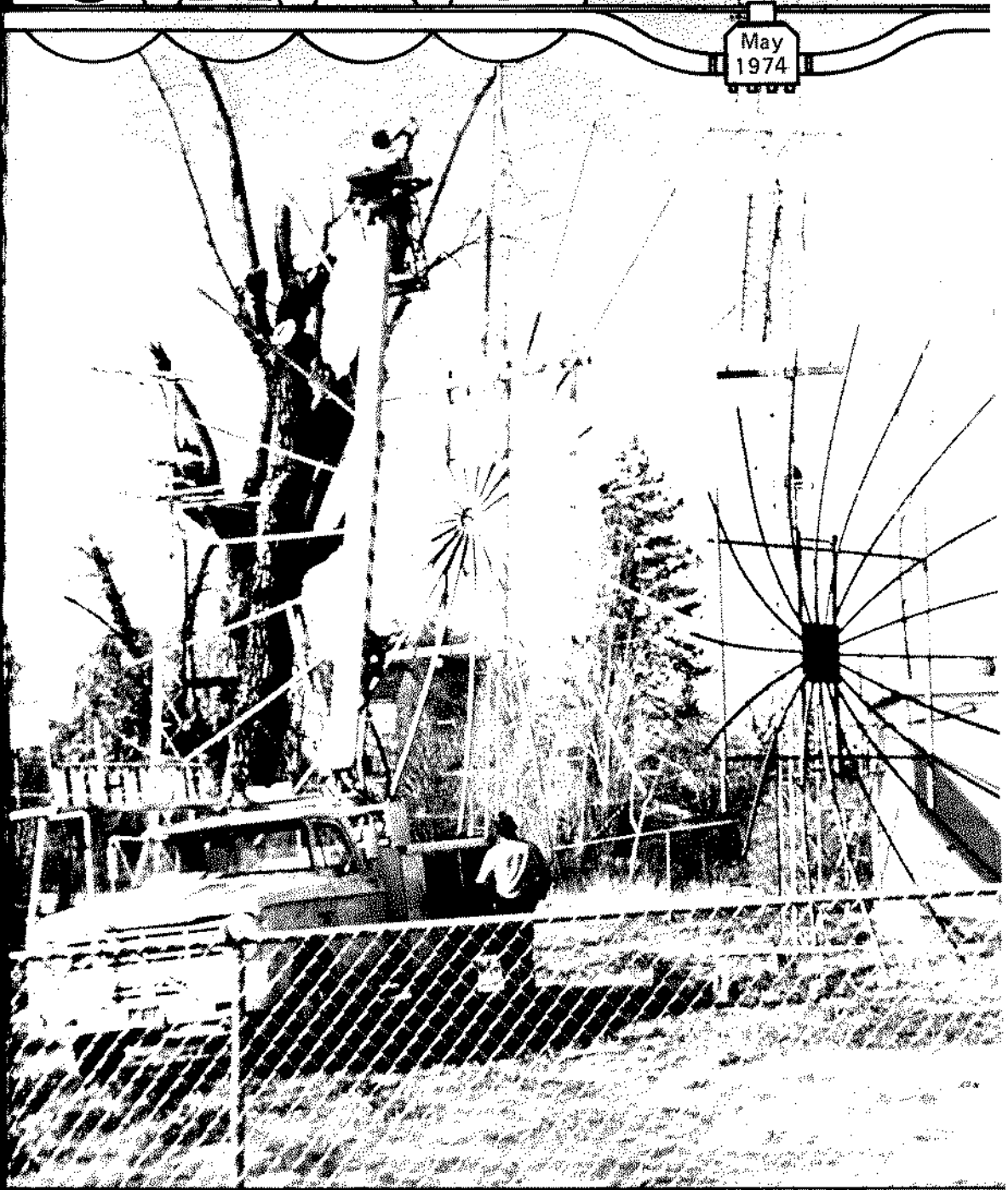

COMMUNITY ANTENNA TELEVISION JOURNAL

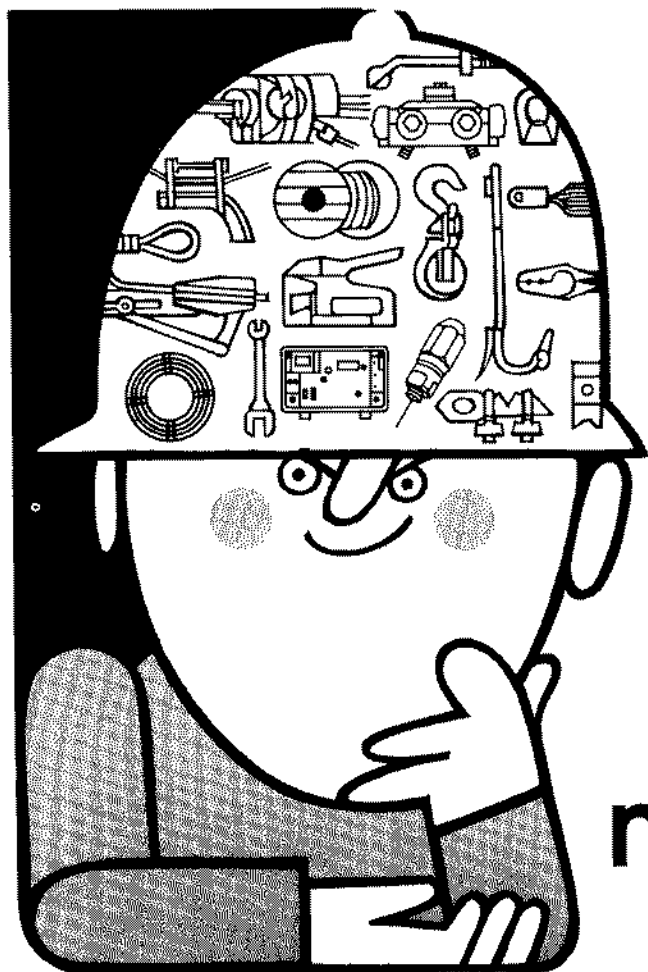

**We
think
of your
needs,
not your
size.**

You know Anixter-Pruzan as the nation's largest CATV distributor. But we're not an out-of-touch giant. We're as close as your phone. Our people in five regional facilities are experienced and knowledgeable in CATV, so we understand your needs. And with the industry's largest inventory, we serve large and small operators the same way. Rapidly. When you need any CATV supplies—fast—think of Anixter-Pruzan. Call us first.

*Atlanta / (404) 451-6368
Los Angeles / (714) 556-6270
New York / (516) 822-8585
St. Louis / (314) 423-9555
Seattle / (206) 624-6505*

We've put it all together!

ANIXTER-PRUZAN

Nation's largest CATV distributor

Back to reality!

Hell, we've been there all along!

Reality is that 3000 "small" systems are the backbone of cable TV. And we've been providing headend to tap equipment to them for 22 years. Equipment that operates on spec, year after year. At a reasonable price.

Sure, along the way we've developed some pretty fancy gear. Innovations at the time, standards today. Like solid-state active and passive devices, heterodyne signal processors, AGC and composite AGC systems . . . even two-way amps that work.

But we've never turned our back on the "small" system guys in the front line providing excellent CATV service where it's really needed. A couple of taps or a 50-mile BOM are big things to us.

We've been paying our dues since 1952. Through good years and bad. And we'll continue doing "small" jobs in a big way in the years to come. Check us out and you'll see what we mean.

2960 GRAND AVENUE
P.O. BOX 13741
PHOENIX, ARIZONA 85002
(602) 252-7731

The CABLEbility People

ameco

STRONG LOGS THAT WORK

AND WORK
and work

Rugged/Strong

CADCO SSL-Series logs are built to take a beating, while out-performing every other CATV / MATV log on the market. Yet SSL-Series logs are lightweight (all aluminum) to simplify tower installation.

Simple Installation

No other CATV quality logs can be fiberboard container shipped (that saves big crating and shipping money); SSL logs come ready to assemble (all the hard work is done; a high hand log will take you 30 minutes to complete). And if an element should ever be damaged, you can replace it completely on the tower with just a wrench!

More Gain

Optimum-engineered SSL series logs are single channel on low band for more gain and better match than conventional logs. One stack will give you the gain of two stacks of other brands! That is more DB per dollar, and lower tower loading . . . an important cost consideration.

MODEL LB-SSL-74

Single channel, center / boom mounting optimized log of superior gain and strength. Solid rod elements. **Gain** — 12.0 db over tuned dipole; **Match** — 18.0 db minimum. Price — \$165.00 each. Stacking kits available.

MODEL HB-SSL-75

Rear / boom mounting for tower legs from 1.5 inches to 3.5 inches od. Solid rod elements. Optimum engineered. **Gain** — 12.0 db over tuned dipole; **Match** — 18.0 db minimum. Price — \$104.50 each. Stacking kits available.

CADCO - The TV People P.O. Box 18904
Oklahoma City, Ok. 73118
(405) 681-5377

CATJ

MAY
1974
VOLUME 1
NUMBER 1

PUBLISHED MONTHLY, AS ITS OFFICIAL JOURNAL, BY THE COMMUNITY ANTENNA TELEVISION ASSOCIATION, INC., OKLAHOMA CITY, OKLAHOMA AS A SERVICE TO THE CATV/MATV INDUSTRIES SERVING THE AMERICAN TELEVISION PUBLIC.

OFFICERS/DIRECTORS

Kyle D. Moore, President
(Cordell, Oklahoma)

Ben Campbell, V.P.
(Dallas, Texas)

G.H. (Bunk) Dodson,
Secretary/Treasurer
(Sayre, Oklahoma)

Warren Fribley, Director
(Painted Post, N.Y.)

William Ridsen, Director
(Cumberland, Ky.)

STAFF

Celeste Rule, Managing Editor
Heather Pennington, Editorial Asst.
Leslie Orwell, Editorial Asst.
Kris Reynolds, Circulation Mgr.
S.K. Richey, Contributing Editor
R.B. Cooper, Jr., Technical Advisor

OFFICES

4209 NW 23, Suite 107
Oklahoma City, Ok. 73107
Tel. (405) 947-4717

Subscription rates: \$10.00 per year for non-CATA members; \$8.00 per year for CATA members; \$7.00 per year for system employed technicians requesting "at-home" delivery. Single copies, \$1.00.

Third Class Postage rates paid in Oklahoma City, Oklahoma; Second Class nonprofit association application to be filed in 1974.

The Community Antenna Television Association, Inc. is a nonprofit corporation under Chapter 19, Title 18 of the Statutes of the State of Oklahoma. No part of the Corporate assets or income shall be the property of its members; such assets and income shall be devoted exclusively to the purposes of the Corporation.

Copyright © 1974 by the Community Antenna Television Association, Inc. All rights reserved. Permission to reprint any material or portion thereof must be given by CATA, Inc. prior to re-publication.

— CONTENTS —

Reception Problems

NOISE — Noise sources from man-made and natural sources often degrade reception quality on otherwise adequate-level signals 8

Measurements

RFI — Radio frequency interference from licensed and unlicensed transmitters provide head end problems for system technicians endeavoring to provide clear pictures to subscribers 19

Test Equipment

MARKER/GENERATOR — First of a series of test equipment you can build in your own shop from directions provided by CATJ 32

Solid State Theory

SINGLE ENDED LINE EXTENDERS — A short course in design techniques for line extenders which will improve your ability to repair your own should they fail; thereby cutting down long factory-repair turn around times 40

System Maintenance

MCS TUBE STRIPS — Over 30,000 of these single channel strip processing amplifiers were built by Blonder-Tongue; many are still in service. Learn a few tricks to keep them in service. 47

CATA-torial (Kyle D. Moore) 4
CABLE-captions (News Briefs) 6
Cable Bureau Report (FCC) 54

— OUR COVER —

A do-it-yourself 40 foot parabolic dish for VHF and UHF that can be built for under \$200.00 in materials (or a 20 foot for under \$100.00) with 40-footer gains in excess of 20 db over a dipole at high band and 25 db at UHF is being readied for complete CATJ treatment in the forthcoming July 1974 issue.

CATA -TORIAL

KYLE MOORE, President of CATA, INC.



Often, with the first issue of a new magazine, the editorial feature is devoted to some form of *eulogy* emphasizing the fine features of the publication. While that may help push the magazine in the eyes of the prospective subscribers, I truly doubt that anything I might add here will alter the impact of Volume One, Number One.

On the other hand, a few editorial comments about the pending Senate Bill 1361 and its sponsors *might alter*, in some small way, that ever increasing threat that *all* CATV and MATV systems are about to pay a *viewing tax*, under the guise of a copyright fee.

On March 4th, 1974 the United States Supreme Court ruled in favor of CATV (and MATV) when it stated that we do not owe copyright fee payments to program owners. The decision handed down by the nation's highest court came in the case instigated in 1964 by the CBS television network, and a handful of program suppliers, against the TelePrompTer Corporation. After trying the case, staying the results, and appealing the case, CATV/MATV (and the nation's viewing public) won the right to watch television without payment of a new viewing tax.

Many anti-CATV forces hoped the Court would rule that cable (or wire) re-transmission constituted a *performance* under the Copyright Act of 1909. Barring such an anti-viewing decision of this magnitude, the anti-viewing forces hoped at least that the high Court would rule that the CATV use of "distant signals" would constitute a "performance" by CATV (distribution by wire or cable). But alas, the high Court found otherwise.

So where do we stand now?

On one hand we have *Senator John L. McClellan* (D.-Ark.) and his Sub-Committee on Trademarks, Patents and Copyright. The good Senator is the proud author of S.1361, a bill he drafted so long ago that it now has cobwebs. The Senator is under tremendous pressure to get the bill released. Copyright owners (people like CBS) want it passed by the Senate (and House) so that copyright owners can start collecting sizable new fees for everything from TV programs to library books.

If the high Court has ruled that CATV/MATV systems do not *now* owe copyright payments for use of re-transmitted (by cable) programs, it is the contention of the Senator *that we will* owe copyright payments when he gets S.1361 written into law.

On the other hand we have people like the United States Justice Department, the television broadcasters, and *even* the copyright owners themselves (in the person of Jack Valenti, of the motion pictures producers group) in outward agreement that small, traditional CATV systems should be *exempt* from any copyright payment.

So we have the Senator on the side of CATV paying copyright, and *almost* everyone else on the side of non-payment liability for at least the small, traditional systems.

Seemingly, those who don't want the liability would somehow be able to convince the Senator that this payment is unnecessary. But there is a bug in the works, and that is *NCTA* (National Cable Television Association).

Immediately after the Supreme Court ruled that we do not owe copyright fees, *David Foster* (President of NCTA) told reporter Jay Sharbutt of the Associated Press, "We have always felt that as a matter of *qualifying cable* to become a *first-class member of the*

communications fraternity, we should accept this (copyright payment) responsibility (emphasis ours)."

Foster was reported as saying his group "still wants Congress to make cable TV operators pay copyright fees". His group, he reported, "represents 1,300 of the nation's 3,000 cable TV systems". He also stated, "This has been a difficult position for the cable industry to come to . . . there are still many cable operators who don't feel they should pay copyright fees."

Foster's reason for this unusual position is, "Quite candidly, a whole lot of our regulatory problems, I think, will either go away or be minimized once we've got the copyright issue behind us".

Qualifying cable as a first class member of the communications fraternity? What does this mean? Does first class mean that we will suddenly be able to *bid* for off-network re-run shows like *Ponderosa*? Does first class mean that we can bid on film packages now being sold directly to the TV broadcasters? Does first class mean we get to bid on special sporting events like the World Series and the Super Bowl? So that we can sell these programs direct to our viewers on a per-program fee (charge), thereby taking them off the over-the-air broadcast facilities?

Boy, that sounds great!

I can just see my 650 subscribers in Podunk, Oklahoma lining up at my box office to buy a ticket to the Super Bowl CATV telecast, *after my industry* outbid the networks for the showing and took the event off of over-the-air television. And right there next to my 650 subscribers holding a \$5.00 ticket-fee will be 2,000 rural folks of Zing County, Oklahoma waving something a whole lot less friendly than a \$5.00 bill!

But that is the great American free-enterprise system, find a new way to corner a buck even if it means 2,000 farmers in Zing County, Oklahoma suddenly lose the Super Bowl.

This lunacy has got to come to a halt. If NCTA has 1,300 member systems and this industry has 3,000 operating systems, there are at least 1,700 sane people still out there. To these 1,700 system operators I make this appeal, on behalf of CATA:

David Foster says our problems will either go away or be minimized "once we've got the copyright issue behind us".

The only thing that will *go away* is money; money from all 3,000 systems to the already well-healed copyright owners.

The only thing that will *be minimized* is our independence to provide a worthwhile television viewing service for a reasonable service charge per month.

If the big systems now cabling the urban cities want to pay copyright for the pleasure of bidding on the Super Bowl, we say let them do it.

But the smaller systems, the Podunk, Oklahoma's of this great land, need to counteract the image portrayed by NCTA's Foster. Apparently the only way to discourage this is with political clout. The CATV industry, in years gone by, has been able to muster tremendous grass roots letter and telegram campaigns to prevent such idiocy. It is time to do this again. Every one of the 1,700 non-NCTA member systems, and *everyone of your subscribers* needs to join the battle against the insidious (proposed) *viewing tax*.

If you agree, let CATA help. The perforated card found between pages 8 and 9 of this issue of CATJ, mailed to CATA, will bring you a package of materials that will outline how you can gain favorable anti-copyright publicity in your own town, and how you can spend a few dollars now to get your subscribers involved in a letter writing campaign, so that future years do not witness 5 cents from every CATV receipt dollar going into some gargantuan copyright fee slush fund.

It is no wonder there is so much pressure to get this law written onto the books. Seventy million potential CATV homes times 5 cents per dollar (or 25 cents a month on a \$5.00 monthly fee) is \$17,500,000.00 per month for copyright owners! And that buys a lot of votes.

CABLE CAPTIONS

A UHF television station in Vermont (WVNY-TV, channel 22) has filed an unusual petition for special relief with the FCC. The petition seeks to have all CATV systems carrying the channel 22 signal carry it uniformly on channel 4. The station (an ABC outlet in a three station market, where the other 2 networks are VHF) says that of the 15 systems now carrying its signal, all but 6 now carry WVNY on channel 4. Of the 6 that do not, 5 are in one major complex in the heart of the WVNY service area and represent a whopping 4,500 homes. WVNY notes that CATV systems must carry VHF stations on their original channels when requested to do so, but that UHF stations suffer by not being able to promote a single "channel number" in their markets. The station contends that, "By requiring same-VHF-channel carriage, the competitive position of WVNY would improve remarkably".

Fort Jones TV, of Fort Jones, California is a typical small system of 4 miles of plant and 103 subscribers. The monthly fee is \$3.50 which gives the system under \$362.00 per month to work with. The system was built in 1958 and carries four channels. The system owner, Ernest Smith, put the system in so his town would have TV. Smith says "the system is too small to afford a maintenance man. By the time we pay pole connections, insurance, power bills and maintain the equipment, on \$362.00 per month there is darn little left! And now there is tons and tons of paperwork, and new regulations every day. Where will it all end? Probably not until I get fed up and pull the plug on the system."

The red-hot Copyright issue was mysteriously placed at the far end of the 1974 NCTA convention in Chicago, almost as if NCTA knew many of the smaller operations would have run out of convention time and money and gone home before the matter came up for forum-type discussion. That's one way to get an issue passed without a dissenting vote; don't bring it up until all of the dissenters have gone home!

Many system operators who recently went through the March 31 deadline to conduct equipment measurement tests for the FCC made one test they did not have to. In the panic to be "legal", many operators made the signal to noise tests on all of their channels, apparently not aware that these tests are required only on signals first picked up within their Grade B (or A) service contours (76.605 (a) (i) and (ii)).

The pre-publication subscription mailing by CATJ (the one with the Video-Quality Evaluation Chart on the back side) was an unmitigated success. Technicians ran 2-1 ahead of system owners in subscribing and many systems subscribed for both themselves and a technician. Several wrote to ask about group rates. If the system itself is a subscriber to CATJ, the first Technician subscription is \$7.00 and all after that are \$6.00 if all technicians are employed by the same system. You might bring this to the attention of your system owner.

The release date of UNDERSTANDING (FCC) FORM 325 has been pushed back until the end of April; several recent changes in the way these forms (especially applications for Certificates of Compliance) are processed or accepted made CATA postpone this release so the book(let) would be really up-to-date.

J.J. Mueller of EMCO CATV in New Hampshire (operating 9 systems of over 50 subscribers and 10 with fewer than 50) has enlisted the aid of his Congressman to try to get the FCC to accept a new format for processing Certificates of Compliance for "small systems" of under 1,500 potential subscribers. Mueller's plan would allow these small

systems to build as soon as possible after being granted a local franchise, rather than waiting out the often year-long CAC process, provided the system will *carry only off-the-air* (i.e. locally received at the head end) signals. Mueller is also asking that these "small systems" be eliminated from non-duplication requirements.

It is "that time of year" again; when summer time weather patterns bring up co-channel signal levels east of the Rockies and freak skip conditions affect low band channels with signals from stations 500 to 1,500 miles away. Systems with less than -10 dbmv antenna levels can expect co-channel problems to be severe for minutes to hours to days in the warmer months ahead.

As soon as CATA officially announced CATJ would be published, a strange thing happened to CATA press relations. In the past, releases have gone out weekly or every other week to all of the trade magazines, including BROADCASTING, the trade-weekly of the broadcasters (most of whom are financially interested in CATV). After the official CATJ announcement, most of the trade press cut way back on publishing CATA news releases and one cut them out entirely. One of these had criticized CATA harshly for "not keeping the trade press informed of CATA activities" when the last five releases we sent to this publication were never run. Apparently that editor uses narrow bandpass filters when he decides what news is *fit to print in his publication*, publishing only that which he agrees with and harshly criticizing CATA for not keeping him informed so that "he can do his duty" in keeping the industry informed. That editor will be disappointed to learn that his *not publishing* our news releases *was not* a major factor in our reaching a decision to publish CATJ!

You will notice that CATJ articles have a slightly different format from other publications you may now read. The basic text of each feature tries to cover all of the bases. Supplemental related-topics are then covered at the end of the article in featurette style. You will also notice that articles are not continued to the rear; each is complete from start to finish. Finally, as advertisers increase, advertisements will group in either the front, on covers, or mixed in with features starting with the fourth feature each issue.

Speaking of advertisers; those who appear in the initial issues of CATJ have more than the usual guts (and we suspect they also have considerable interest in helping traditional CATV systems). Advertising in a sight-unseen publication published by a new trade association takes a strong backbone. *Let them know you appreciate the support!*

Now the NCTA Board has elected Bruce Lovett as their new Chairman (for the coming year) there is speculation that *any outward image* of being concerned about small system problems will *vanish* from the NCTA. Lovett is known for his *big is good* philosophy; and he reportedly had much to do with the demise of NCTA staffers Bill Smith and John Paul Johnson, both of whom worked for the betterment of the small system operators. The small system department at NCTA has been trimmed to a single, hard-working gal, (a veteran of more than 15 years) who is under intense pressure to hold on to the few small system operators that NCTA still has in the fold, while Prexy Foster is bounding about the country being quoted as being *in favor of things like Copyright payments.*

Quote of the month: From the March 4, 1974 Supreme Court Decision that ruled CATV/MATV systems do not owe on copyright; "By importing signals which could not normally be received with current technology in the community it serves, a CATV system does not, for copyright purposes, alter the function it performs for its subscribers, but the reception and rechanneling of these signals for simultaneous viewing is essentially a viewer function, irrespective of the distance between the broadcasting station and the ultimate viewer". *Et tu, David?*

POWER LINES - MOTORS

LIGHTNING & TRASH

CATV NOISE

The perfect CATV head end is usually located well out of the town to be served, well away from busy highways and located so power distribution lines are not within the immediate antenna fields.

There are few *perfect* head end locations.

Usually, one or more compromises must be made. The system planner must consider land availability and price, the length of the trunk run, and the trunk cascade to the most distant reaches of the community. Finally, if a tower is involved, local zoning ordinances, and FAA approval enter into the equation.

Consequently, most CATV head ends do have *some noise present on some channels some of the time*. That noise is the subject of our report.

DEFINING NOISE

CATV system noise can usually be traced to one of four sources.

(1) *Amplifier noise* — caused by excessive *noise figures* in one or more signal amplifiers (starting at the head end and working through the plant);

(2) *Man made electrical noise* — originating on power lines, in electrically operated equipment, or in combustion operated equipment fired by electrical spark;

(3) *Atmospheric noise* — created by electrical discharges in the atmosphere (ie. thunderstorms with lightning);

(4) *Out-of-band noise radiation* created by signal processing units (on-channel strips and hetrodyne signal processors) which generate *noise* on adjacent channels in addition to processing signal(s) on the desired channel.

Amplifier noise and out of band noise radiation from processing equipment will not be covered at this time. Atmospheric noise and man-made electrical noise will be our subject this month.

ATMOSPHERIC NOISE

The most common form of atmospheric noise we encounter is that created by thunderstorms (with lightning). The discharge of millions of volts of potential by Mother Nature creates a "spike" of radiated RF (radio frequency) energy which begins down in the VLF (very low frequency) range and extends up well into the VHF (very high frequency) region.

Typically, such a discharge occurs with a very rapid rise time and its potential subsides within a second or two of real time. You can "see" such an event on a spectrum analyzer such as the TekTronix 7L12.

The effects of lightning can be observed on all of the low band TV channels (2-6), within the FM band (88-108 MHz) and into the high band (channels 7-13). The most damaging "interference" is on low band signals however as the RF po-

tential at low band from lightning discharges is much greater than at high band. In fact, the RF potential is greatest at the very lowest frequencies affected; and scientists have "tracked" thunderstorms in the southern hemisphere from locations in the northern hemisphere by "tuning in" signals known as *whistlers* that these storms create in the VLF range.

Lightning affects at our low band TV frequency range, on our pictures, is a function of ratios; our desired (TV) signal to the undesired RF discharge from the lightning.

Lightning discharges are apparently *modulated* at a relatively low frequency rate; and the interference, while short lived, is completely degrading while it exists. The photos illustrate a signal with no lightning present and with a discharge "covering" the signal.



ABOVE — lightning free picture;

BELOW — start of lightning strike



Because of the intensity of a typical lightning discharge, the typical processor

unit "sees" the discharge as a sudden signal enhancement. In some processors, this causes the AGC to clamp-down on the processor gain, causing the real signal to drop way off (on the line) for the period the discharge is present. This only worsens the situation for the cable viewer since the already lightning-noise laden signal is further level-lowered on the CATV plant; causing it to drop into snow (amplifier noise) *plus* lightning noise.

In other processors, the lightning discharge so completely masks the sync signals which the AGC in the processor references to, that the processor can no longer "see" the sync signals at all. Lacking detection of this AGC reference signal, the processor simply *shuts off*; leaving the channel blank. This keeps the customers from being annoyed by lightning discharge noise, but, it also leaves

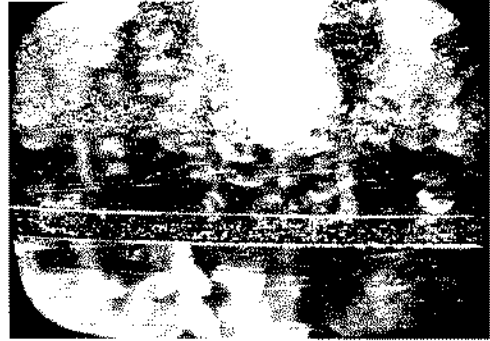

ABOVE — Buildup continues;

BELOW — and peaks heavily

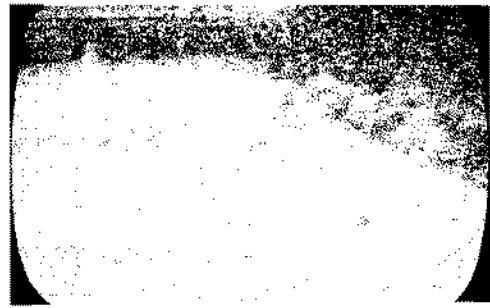

them with programming gaps. And if the AGC has a delayed return circuit in it,

the channel may remain blank for several seconds before it comes back on.

Lightning discharges vary in intensity; as intercepted at your head end. Lightning discharges themselves vary in intensity. In addition to this variation, we also have:

(1) Variations in the location of the discharge as that relates to the receiving antenna "pattern" (ie. a discharge occurring off to the side of the antenna array will be reduced in intensity by the natural rejection of the antenna pattern);

(2) Variations in the incoming *polarity* of the lightning discharge (ie. a discharge that is predominantly vertically polarized as it arrives at the receiving antenna will not do nearly as much damage as one that is horizontally polarized like the receiving antenna).

The ratio of the desired signal to the non-desired lightning discharge is the key to the degree of interference you can expect.

Measurements conducted over several summers indicate that lightning discharges within 10 miles of a low band receiving site (ie. one with low band signals coming off the air on one or more low band channels) often exceed +30 dbmv (32,000 microvolts); and that discharges 10-30 miles away, and within line of the receiving antenna array pattern, often measure in excess of +20 dbmv (10,000 microvolts).

(The intensity of these discharges is difficult to grasp; tests indicate lightning discharges as far as 200 miles away often rise as high as -20 dbmv on 10 db gain receiving antennas only 100 feet in the air, on low band channels!)

CURING LIGHTNING INTERFERENCE

Unlike co-channel or even man-made-noise, lightning discharges do not come from a distinctive *point-source*; that is, a single location with a known angle of ar-

rival (reference the desired signal heading) against which you can phase antennas for antenna pattern shaping, and interference elimination.

So common stacking techniques are not satisfactory.

Analyzing the *source*; it can be:

- (1) in front of the antenna
- (2) behind the antenna
- (3) off to the side of the antenna.

It can also be:

- (4) high above the horizon
- (5) right on the horizon
- (6) or, beyond the horizon.

It can be almost anyplace around you. But as a matter of practicality, it is likely to be behind, off to the side, higher than or beyond the horizon from your receiving antenna, more often than it is going to be *on the horizon* and dead *in front of your antenna*.

So if you can so pattern — shape your antenna so that you eliminate (or greatly reduce) your antenna pattern lobes (ie. pick up) in all directions *other than* on the horizon and in front of your antenna, you will do about as much as you can expect to do to reduce the disruption of lightning discharges.

Such an antenna pattern is discussed in some detail later in this article.

Not all atmospheric electrical energy is dissipated by lightning discharges. Lightning discharges are violent, sudden releases by mother nature. The same type of "weather pattern" which creates lightning often also creates a form of discharge known as *precipitation static*.

Precipitation static usually occurs during a light mist or just ahead of a rain storm. An electrical potential (ie. difference) existing between the earth and the atmosphere causes electrons (ie. energy) to "move" from the antenna array to the atmosphere. When this happens, the antenna array acts as an electrode (ie. picture a capacitor element) and the energy

stores on the antenna elements until it is potent enough to "jump" to the atmosphere. This is sort of lightning in reverse.

The voltage involved seldom exceeds 50-70 volts potential, but it is "modulated" by the random motion of the electrons and this creates a wide band type of noise that is most prevalent in the lower VHF region (ie. below channel 2 up through channel 6).

Precipitation static is most common in regions of the country where thunderstorms do *not* occur. You know you have it when a normally good quality low band signal starts to get white flecks (with a few black flecks) of noise in it, the flecks building stronger and stronger over a 10 second to one minute period, and then suddenly disappearing entirely with the picture returning to normal quality levels. The disappearance of the noise occurs when the precipitation static makes its "jump" to the atmosphere and the potential (difference) is eliminated. The noise will return when the potential between the antenna array and the atmosphere begins to build once again.

The usual solution to this problem is to properly ground all antennas. That is, remove the antenna array as an *electrode* upon which precipitation static (noise-voltage) can store before it "jumps" into the atmosphere.

CATV systems utilizing wooden telephone poles along the Pacific coast, in the Rockies and Smokies, as antenna support masts, are most likely to experience this problem. If you cannot install a good copper earth driven ground to bond all antenna booms to ground, directly, the best choice is to replace the wooden poles with a metal tower structure that is well grounded through its own base (and guy wires).

In short, to avoid precipitation static, keep your antenna booms at *ground* potential!

MAN MADE NOISE

Noise sources created by man are often the most perplexing to the CATV system operator.

We are all familiar with ignition noise from combustion engines. Most of us are also familiar with noise created by electrical motors.

In addition to these common noise sources, we frequently encounter noise that originates in the power distribution lines, or worse yet, originates in some appliance or piece of machinery, and is carried for a mile or two by the power distribution lines; radiating into the air all the way along its "transmission path."

Add to these common or frequent problems those created by the farmer across the road with his electric fence (*any* version of which has the potential to be a real problem), or the neon sign on the motel a mile away and you have a seemingly endless variety of forces working against your desire to deliver interference free pictures to your subscribers.

Before you can move on to either fix or repair any noise problem, *you must locate the source*. Keep in mind that while any electrically operated apparatus can be a noise source, the apparatus itself does not have to be a *point-radiation-source*. That is, the malfunctioning device that is creating the noise may not be the (only) radiator of the noise generated.

To put it another way, if a malfunctioning electrically operated deep fryer can (and will often) radiate not only from the fryer itself, but it will also radiate from the power lines that feed that restaurant back as far along the power lines as the lines are isolated from the remainder of the power distribution system by a step-down transformer or isolation transformer.

If the restaurant is on its own secondary feed (for power), the wiring within the building is all of the "antenna" which the fryer has; and its interference range will be limited by the "gain" of its antenna.

Radiated noise tends to be broad band in nature; that is, like lightning discharges, noise created by a malfunctioning (or improperly installed, or improperly designed) electrical apparatus (including the power line as a noise source itself) tends to start low in frequency (VLF range). And, like lightning discharges, the higher frequencies (ie. into VIII^F) are usually *only evident close to the actual source*.

To put it another way, noise created by virtually *any* source travels further (ie. propagates over greater distances) at the low frequency end of the scale than at the high frequency end.

This is a very useful *trait* because this allows us to devise a relatively simple "handle" on solving the source-location problem.

Table 1 illustrates a real life noise tracking experience.

The noise from this source (a loose down guy on a power pole that allowed electrical energy to discharge intermittently to ground) could be heard over a several mile area on an AM automobile car radio. (By tuning the car radio to a locally clear AM frequency, the burrupp/ burrupp noise could be clearly heard.) Unfortunately, at this low frequency, several *other* noise sources could also be heard and the mixture of two or more sources, as propagated by the power lines, left the noise-searcher with the distinct impression he was chasing an "everywhere's source".

By placing a shortwave receiver in the car (a Heathkit model GR-78 battery operated receiver that tunes 190 kHz to 30 MHz is an excellent receiver for this purpose) on the front seat, and installing a temporary 100-140 inch steel whip antenna to the vehicle on *insulated clamps*, the noise-searcher can start off on the low frequency end of the radio spectrum and drive out the suspected area searching for noise. As the noise is heard in the AM broadcast band, move to a clear (ie. non

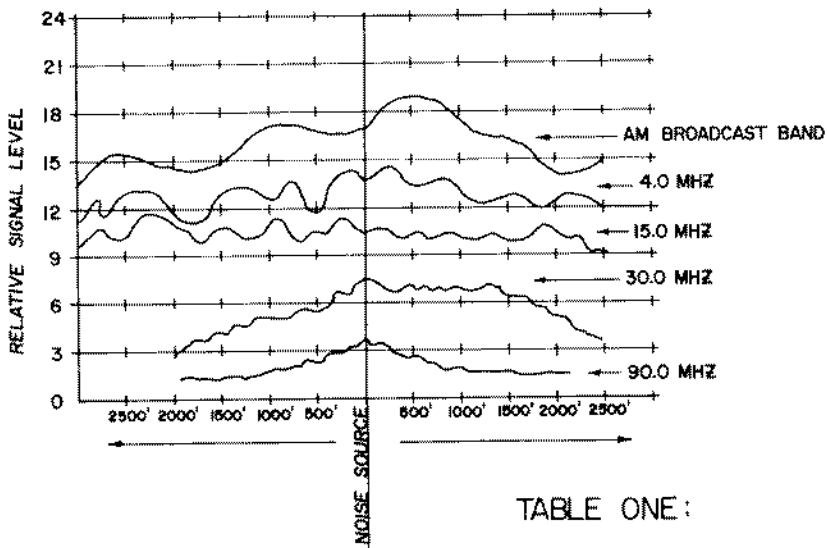

NOISE METER ■ FM

signal occupied) spot in the 4.0 MHz region. If the noise is heard there, move immediately to a clear spot in the 15.0 MHz region.

As you get closer and closer to the noise source, you will be able to hear the noise on higher and higher frequencies.

By the time you get to the 15.0 MHz region, you are getting within a mile (perhaps just a few blocks) of the source itself. The signal level meter (commonly called an "S" meter) on the battery operated shortwave receiver becomes a useful tool at this point because it indicates the relative level of the noise as you drive along.

However, the "S" meter can also mislead you as Table I indicates. Noise sources propagated along power distribution lines tend to go into and out of "phase" as you drive along the line. This results in a wide variation in the indicated level even within a distance of a hundred feet or less, falsely suggesting that you have passed the "location" of the source.

To solve this "phase" problem, the noise-searcher must constantly move *higher and higher in frequency* with a noise-seeking receiver as he moves *closer and closer* to the source itself.

Seemingly, once you have moved beyond the 30 MHz upper limit of the battery operated receiver, you could switch to a battery operated FSM and a dipole or whip antenna. After-all, an FSM has a built in meter and this is useful to indicate noise level.

Unfortunately, while you can press an FSM into service in a pinch, it will usually *not* have adequate sensitivity to handle the relatively low (noise) signal levels present.

A better technique is to employ a small hand held portable FM receiver (covering 88-108 MHz). The device that is shown in diagram 1 is a simple signal level meter which plugs into the earphone

(Continued on Page 14)

The simple noise (audio level) indicating meter shown here can be constructed in a mini-box and plugged into the earphone jack on a portable FM receiver. The 0-500 micro-amp meter with a detector diode (1N914) alone, *without* an RC circuit (R1, C1), will react wildly to individual audio spikes from the noise source. R1, C1 were chosen to *dampen* this reaction so the meter movement slowed down.

With the particular receiver/meter you may employ, you may have to experiment with the RC values to arrive at a proper dampened value to keep the meter slow enough to not react to small variations.

Another potential problem is a receiver with an AGC system that will not allow noise input *up variations* to translate into increased meter readings, in which case disable the receiver audio AGC.

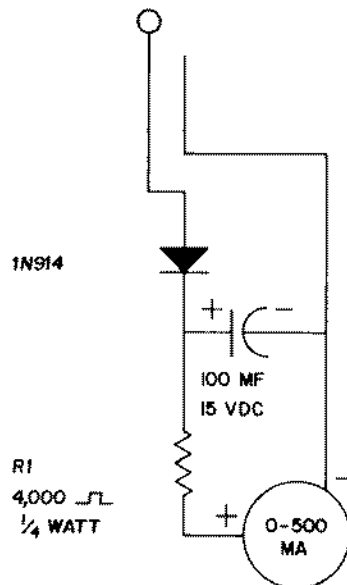

jack on portable FM receiver. The FM receivers commonly available in this configuration have sensitivities on the order of ½ microvolt for (normal) 10 db quieting. This puts it 10-20 db *ahead* of most FSM's for low end sensitivity.

When you reach a point in your noise search where you can detect noise at (or in) the FM broadcast band, you are (as Table 1 suggests) within 500-1000 feet of the culprit source.

At this point you may have some difficulty zeroing-in on the actual device causing the noise. This is because power (and telephone) down guys, service drops and even nearby cable lines can and do *re-radiate* the noise source. And because you are doing your "leg work" underneath the power lines, with telephone and cable between you and the power lines, considerable "phase" and re-radiation can be expected. And all of these sources tend to "mask" the true *point source* of the radiation.

Once the source is pinpointed, you have of course the problem of correcting it. The law is on your side, as is indicated here. Machinery or power lines that radiate noise are in violation of FCC Rules and must be corrected when brought to the attention of the owner.

You will usually find the power utility to be helpful; but overworked and understaffed. This is especially true of the "staff" which the utility *may* maintain to *locate* noise sources. If you merely turn in a *complaint* that they have "noise" *somewhere along Oak Street*, you are in effect saying "send out your noise locating expert to find the noise".

If, on the other hand, you turn in a complaint that says "pole number G-456-A is radiating noise" the power utility can by-pass their overworked noise locator man (or crew) and schedule a line crew to come out and repair the problem. This will save you many weeks of waiting and

get you much faster results.

Once the crew is scheduled on the location to fix the problem, you should also be there with your noise locating equipment. A line man on a pole, moving wires and hardware around while you monitor on the ground can be directed by you as to what piece of hardware, ground bond, etc. is at fault. As he moves things around, you will see results on your noise-indicating receiver set up. And if by some chance you guessed the wrong pole, while you have the lineman on the spot you can usually get him to check poles on both sides for problems as well. In effect, you have a margin for error if you handle it like this.

While the power company *knows* the FCC rules and *knows* they must cooperate to fix a problem that you may have (or risk having a nasty tangle with the FCC and your spreading the word around town that *they* are at fault for the blemishes in channel 3), the restaurant with the defective fry cooker or the motel with the poorly installed neon sign may be something else.

Although the "law" is on your side, it is not something that can be handled by local law. If you cannot get the problem repaired in a friendly fashion with the owner of the equipment, your only recourse is (1) the weight of public opinion, and/or, (2) filing a formal complaint with the nearest FCC *regional office*.

Public opinion usually involves finding someone in town who has more influence with the owner of the defective fry cooker than you do, perhaps a banker, or city councilman.

If that fails, you are down to filing a letter with the FCC; detailing what you have done to locate the noise source, and to encourage the owner of the defective piece of equipment to voluntarily correct the fault. At the same time, you must explain how this defective unit is causing

harm to your system and service, pointing out that you are operating under the rules and regulations of the Commission, but that you cannot deliver the quality of pic-

tures required by Part 76 as long as this uncontrolled interference source continues to operate.

(Continued on Page 16)

REMEDIAL NOISE ELIMINATION STEPS — SOME SOURCES

Keep in mind that the local electrical company can be held accountable only for noise which their system creates, and that noise created by their service customers must be handled between you (the offende) and the customer (offendor) of the electric service.

One of the most effective known noise eliminators is a capacitor, as large (in capacitance) as possible, placed as close to the noise source as possible. *NOTE:* In the case of portable appliances, the capacitance possible is limited by UL codes which state that the maximum current to ground through the capacitor may not exceed 0.3 mA to prevent electrical shock to the user.

General procedures follow:

Thermostatic Devices

Neon Signs

*Oil Burners/Ignition Type
Industrial Equipment*

Commutator Type Motors

Belt Static

*RF Heating (including
diathermy, induction,
dielectric)*

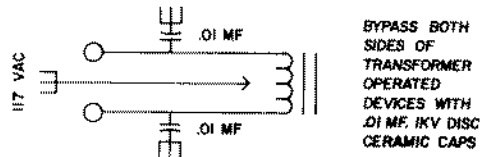

Filter as close to make/break contacts as possible.

Insulate thoroughly from metallic surfaces; replace defective neon tubes; bond together any isolated (floating) metallic material in the field of the sign.

Install heavy duty suppressor-type spark plugs and capacitive-type line filter at unit AC connection. Bond motor, burner unit and furnace to an effective earth ground.

Turn down (resurface) commutator, reseal brushes, filter at motor and ground case to belt to reduce static discharge.

Bond machines together and directly to ground. Apply graphite type belt dressing to belt to reduce static discharge.

Determine operating frequency and harmonics (often centered near 27 MHz which makes dandy 54 MHz (2x) and 81 MHz (3x) harmonics). Unit should be well shielded and grounded to good earth ground. To cut down interference, reduce drive to final (output) amplifier and install traps or filters to cut out harmonics.

This should always be done with a copy of the letter to the owner of the defective unit; so that he knows what it is you have reported and he in turn knows what to expect from the FCC.

Commission field offices are swamped, but eventually they will respond to you and to the owner of the defective unit directly. The FCC will attempt to handle

the matter by mail; but barring that, they will eventually send an engineer out to inspect the problem.

Several months (perhaps a year) will lapse from start to finish if this is the way the problem goes; so don't expect miracles or overnight service. Again, the best procedure to follow is to work it out locally, if at all possible.

CATV RECEIVING ANTENNA ARRAYS VS. NOISE SOURCES

Designing an antenna array which will provide the greatest degree of protection against lightning noise demands that the antenna array have (1) highest possible front to back ratio, (2) highest possible front to side ratio, and, (3) lowest possible front angle-of-radiation. This is not unlike the type of pattern which you require for minimum co-channel or minimum pick up from discrete noise sources that you cannot control, such as highway traffic.

Any type of yagi antenna array makes a poor choice for this situation since a yagi not only has a number of side and rear lobes in the horizontal plane, but it also has a number of minor up and down lobes in the vertical plane, some of which are extremely responsive to signals that come to the antenna at elevated angles of 3, 5, or 10 degrees above the horizon (which lightning within 50 miles definitely does).

Many systems with -10 dbmv to 0 dbmv inputs from their present antennas (ie. a single yagi or log) on low band channels could measurably improve their rejection of lightning discharged RF by changing out to a log antenna array. A log antenna does not exhibit the many minor vertical plane lobes of a yagi, and as a consequence it will reject these high-angle-arriving signals better than a yagi. An array consisting of four logs, spaced two wave length wide by one wave length high (ie. a box array of four logs) will not only improve the signal to noise (including lightning) ratio, but will reject lightning caused noise from any storms except those directly in front of the array on the antenna heading.

190 KHZ-30 MHZ NOISE

LOCATOR PACKAGE

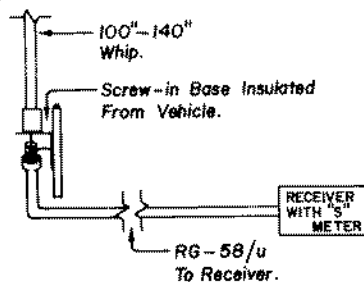

The equipment suggested consists of the following: A battery operated receiver that covers the range 540 kHz to at least 30 MHz; a whip antenna (steel Citizens Band 102\" whip is adequate) mounted on an insulated base so it floats above the vehicle body ground shell; a short length of RG-58/U (50 ohm coaxial cable) connecting the whip to the battery operated receiver. By isolating the antenna and the receiver from the vehicle, vehicular (ignition) noise is minimized. If ignition noise (pulses) from your vehicle can be heard, switch vehicles or take steps to cure the noise originating in your vehicle. See text for information on test procedures.

NOISE PATHS

There are three common noise paths to your receiver from the noise source.

Conduction takes local noise from a source to your receiving equipment through the service wiring in the facility and into the power supply of your equipment through the 110 VAC connection. At VHF ranges, this mode of noise transmission usually comes only from sources very close to the receiver.

Induction paths follow the power lines, metal fences (ie. barb wire), telephone company strand and other "inducible" materials. Noise sources at VHF usually follow induction paths for only short distances before they either attenuate below interference levels or convert into radiation paths.

Radiation paths are the most common problem paths at VHF. The source couples into a radiator (ie. an antenna) which in turn allows the source to radiate through the air.

SPARK DISCHARGE

Interference categories break down into a trio.

Spark discharge sources are common household appliances and thermostatically controlled devices. Brush type motors found in portable mixers, electric shavers, vacuum cleaners and small shop motors are troublesome spark discharge devices. These devices tend to have potent near-field interference potential but because of the small motor sizes, seldom radiate more than a few hundred yards.



Spark discharge devices often create "bands of interference" made up of predominantly black streaks

Thermostats located on heating pads, aquarium heaters, water heaters and chicken brooders have a slow-break contact type of construction. When these contacts break, an arc occurs which produces a spark discharge. Items such as brooders, electrical fences and carbon filament light bulbs (still found in rural areas) can affect a large area with interference because of the large radiating "antenna area" often connected to them.

The typical sounds associated with the spark discharge are a frying or grinding sound, popping or buzzing. The thermatic devices have a characteristic sound that goes bzzt-bzzt-bzzt; on for several seconds and off for several seconds.

The fluorescent light has a characteristic 120 cycle per second roar about it; and they very seldom cause problems above 15 MHz.

A roaring, frying noise that comes on and stays on for some period of time, or, goes on and off randomly, is a characteristic of a defective power line (ground). In rare situations, it may come on and go off at certain times; if it does, check the time local street lights come on and off as the source may be a power line feeding a street light.

RF RADIATION

There are many devices capable of RF radiation. Helium welders, induction soldering machines, TV receivers, TV mast mounted pre-amps and diathermy machines are among the more common sources.

The sounds associated with this kind of interference are whining, buzzing, whistling or warbling. The picture usually has an RF beat appearance to it.

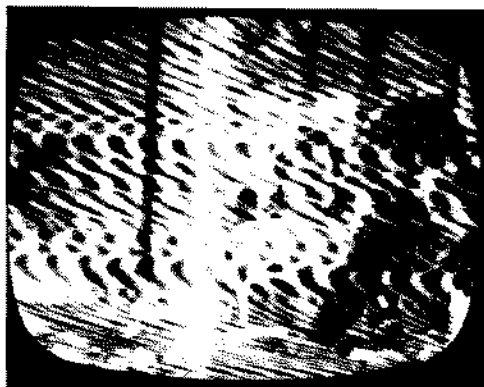

RF radiation from defective mast pre-amplifier

In small communities, an old mast mounted pre-amplifier left plugged in and forgotten will often partially fail; particularly when one half of the twin lead on the input fails. In this "unloaded" condition it will oscillate, causing an RF beat in one or more channels.

Diathermy, heliarc welders, induction soldering machines, and TV receivers that radiate RF interference usually require better shielding.

ELECTROSTATIC DISCHARGE

This type of interference source often has no connection (directly) to electrical circuits. Guy wires rubbing together, dissimilar metal down spouts and gutters moving against one another in the wind, roof top weather vanes, or loose ground bonding straps on totally "cold" strand lines are common causes.

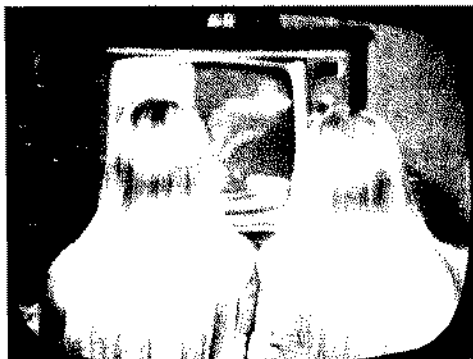

Fleck-specks usually suggest electro-static discharge from a non-motor source.

EFFECT OF RF (FREQUENCY) ON NOISE SOURCE LOCATIONS

Lower frequency noise components tend to propagate through and around power line transformers. In the AM broadcast band, noise heard may actually peak higher in intensity at some point other than the noise source, than at the source itself. This is also true through the lower half of the HF (high frequency) region up to approximately 15-30 MHz, where the region begins to become more local-

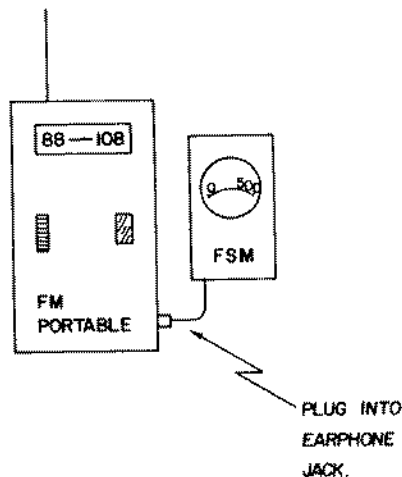

ized. By using lower frequencies to spot the "area" where the noise is located, higher and higher frequencies are utilized to pin the source down to a specific area. Final determination is made by using the FM broadcast band as a location-frequency-range.

LIGHTNING AT HIGHBAND/UHF

Within 0-10 miles of a lightning discharge, the noise impulses from the discharge can disrupt even high band VHF and UHF signals.

Lightning impulses at high band (and UHF) are markedly lower in level than at low band VHF. A lightning discharge that totally disrupts a 500 microvolt low band signal will usually only cause moderate "flashing" on a high band 500 microvolt signal and picture jitter on a 500 microvolt channel 14 signal.

However, a high band VHF pre-amplifier with a wide open front end, or a UHF broad band pre-amplifier, when presented with a broad band noise source "spike" such as a lightning discharge, will often *momentarily overload* from the lightning induced RF present, causing the amplifying devices in the pre-amplifier to saturate and "shut down" (or cross modulate) for a brief instant.

RFI - RADIO FREQUENCY INTERFERENCE

One of the more frequently encountered type of head end interference originates from an RF (radio frequency) source.

RF sources have one thing in common, they *beat* with the desired carriers we are trying to receive and process for our system producing various interference patterns in our pictures (or to our sound channels).

RF sources proliferate in heavily suburban areas and one of the problems encountered by systems built in these areas is entry into the system of undesirable carriers. Both the head end and the plant itself are susceptible to RF entry. We will confine our discussion at this time to the head end.

Sources

A complete list of potential RF interference sources would fill this article *and* issue of CATJ. However, learning to recognize the various *categories* will give the interference source seeker a handle on tracking it down.

RF sources can be broken down into two broad categories, those that originate with a licensed (crystal controlled usually) transmitter source, and those which originate at unlicensed (usually low power) transmitter sources.

All licensed transmitters have a set of technical standards to which they must adhere. These standards specify the amount of harmonic output content which a transmitter may have and still remain "legal". Generally, the FCC sets the amount of harmonic radiation from a licensed transmitter at a low enough (power output) level so that this harmonic energy, if radiated into the air, will not interfere with reception in other (radio or television) services.

A licensed (by the FCC or DOT) transmitter, if it is radiating excessive harmonic

output, is the easiest problem to deal with because you have the persuasive powers of the licensing authority on your side in getting the problem corrected.

An unlicensed transmitter source falls into one of two categories, those which the FCC allows to operate without a license at very low power input levels (usually less than 100 milliwatts), and those which operate without such authority. The owners of the former are perfectly aware that they own and operate a transmitting device. The owners of the latter may not even be aware that they are operating a transmitter.

Frequency Correlation

No transmitters are authorized to operate directly in the VHF television bands in the United States or Canada unless they are licensed in the *television broadcast service* (*). UHF channels 14-20 are shared by some two-way radio services in the largest ten markets of the United States; elsewhere this range is reserved for the *television broadcast service* up through channel 70. Above channel 70, the spectrum is again "shared" with two-way radio services.

Thus, for the most part, the only signals (ie. carriers) which should appear *inside* of these spectrums (2-13 and 21-70) are those broadcasted directly by television transmitters licensed by either the FCC or the DOT.

Knowing this makes the signal source seeker's job a tad easier since we are chasing the guys in the black hats; ie. anyone other

(*In close proximity to some military bases, shared use of the VHF spectrum occurs with military forces acting out maneuvers and using communication equipment operating for short periods of time.)

than broadcast which we find inside of the spectrums.

Very few transmitters actually go berserk and begin to transmit directly in our sacred television allocation spectrums on their own. They end up transmitting there because of either some technical malfunction or because some totally unqualified operator has gotten his hands on the controls. Both situations can be corrected, if *you can locate* the offending transmitter!

It is a little bit like playing cops and robbers and you are the detective.

You can usually develop two important "clues" to the culprit, the (approximate) frequency of the interfering carrier, and the direction from which it is coming.

The frequency is the most important clue of all, as we shall see. The direction will get you started in the right heading once you have an idea of *what it is* you are looking for.

Basic Review of Transmitters

To generate a carrier, a transmitter of modern design employs an oscillator to create the original "signal". Most transmitters we will be running into are *locked* on a single frequency by a crystal controlled oscillator. The crystal is a finely honed piece of quartz which, when shaped just the right way and subjected to just the right mechanical stresses, will "generate" an RF carrier on a more or less specific frequency when placed in an *oscillator circuit*.

The oscillator circuit usually operates at a *lower* frequency than the transmission (ie. broadcast) frequency of the transmitter. For example, a 55.250 MHz channel 2 visual carrier can be actually generated at a relative-low frequency of 9.208333 MHz. Circuit designers want to generate the initial frequency as low as possible to insure that the *stability* of the frequency of the generated *wave* is as constant as possible.

Therefore a 9.208333 MHz oscillator is carefully stabilized in a controlled environment (ie. temperature stable), and then it is *multiplied* up to the 55.250 MHz channel 2 visual carrier frequency.

How? By frequency multiplier circuits in the transmitter.

A frequency multiplier circuit has an input and an output, just like a CATV amplifier. Only it is purposely designed so that the *input* operates on one frequency (9.208333 MHz) while the *output* is tuned (with a tuned circuit — to *twice the input frequency*, or 18.41666 MHz. The circuit actually doubles the input frequency.

Now, if we follow the doubler stage with a second stage that also multiplies, one that has an input tuned to 18.41666 MHz and an output tuned to *three times the input frequency*, our 18.41666 signal suddenly multiplies by 3 and becomes 55.24998 MHz (or 55.250 for rounding off).

All of this multiplying business is possible because virtually *any amplifier* stage (or circuit) has the inherent ability to produce output at not only the input frequency (ies) but also at harmonic output frequencies. In frequency multiplier stages, the design engineer takes advantage of this inherent characteristic by *purposely* tuning the output circuit to a multiplied frequency.

So what about the big power amplifier stage in our example channel 2 transmitter? If virtually *any* amplifier can generate harmonics, how about 2x 55.250 or 110.500 MHz? Won't there be a signal coming out of the channel 2 transmitter at that frequency also as well as, 3x frequency, or 165.750 MHz and 4x frequency, or 221.000 MHz?

Yes, in fact there is harmonic energy coming from the 55.250 MHz transmitter, and that is where the FCC technical standards for the television broadcasters comes into play. The FCC says that *any* energy radiated by the licensed television transmitter must be radiated at a level at *least* 60 db *below* the authorized output on 55.250 MHz.

The television broadcast transmitter people who design transmitters solve this one by installing a device known as a *bar-*

monic filter right at the output of the transmitter to catch and trap that non-55.250 MHz energy at the transmitter before it gets to the antenna. Then the antenna which is designed to be an effective radiator (ie. resonant) at channel 2 (55.250-59.750 MHz) is not very effective as a radiator at 110,500 or 165,750 MHz, etc.

The same principal applies to virtually every transmitter licensed by the FCC. The amount of harmonic signal(s) which the transmitter may radiate is specified by the FCC in the applicable sections of the Rules and Regulations.

If this is true, how can a transmitter interfere with a CATV off-the-air receiving system?

Well, we assume for the purposes of this discussion that the CATV receiving system is not only of adequate design, but also of modern design. The premise here is that the

CATV system is doing everything it can do, but that the interference still exists.

So what can happen at a transmitter to cause receiving system problems? And, how will an understanding of what might happen assist you in curing the problem?

Remember that a signal that appears inside of our *sacred* television broadcast spectrum is not supposed to be there, and that we are going to have to track it down, for source, before we can take steps to have it removed.

To track it down for source, we are going to have to backtrack through a simple mathematical deduction to help us pin down *where* the signal *might* be created. Once we have done this, our possible *sources* for the transmitter are narrowed down quickly, or so it would seem.

The most valuable tool you can utilize is a high resolution spectrum analyzer, and

WHERE TRANSMITTERS RADIATE

Transmitters have the capacity to radiate energy at several points; including the output coax connector (to the antenna). In most good transmitter designs, all oscillator/multiplier stages are shielded against direct radiation (from the stage itself), and against radiation back through transmitter power supply wiring. However, units in the field for some period of time may no longer be adequately shielded or they may have alignment problems or even have their harmonic filters removed or bypassed. This chart identifies the points to check out.

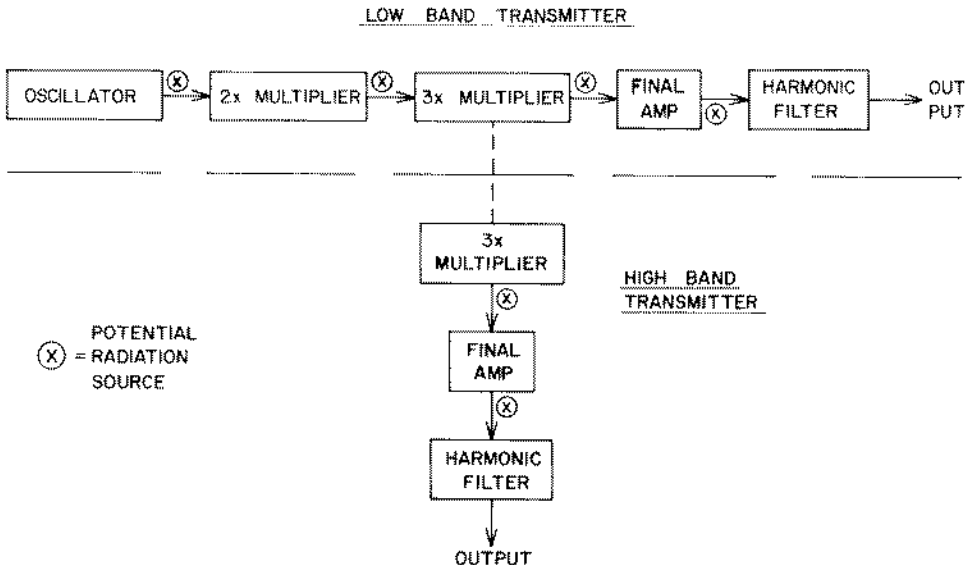

you probably don't own one, or have access to one.

The spectrum analyzer is a simple several thousand dollar tool that allows you to visually display any signals which might be present in its adjusted bandwidth display. With one on your bench you can quickly spot the almost exact location, or frequency, of an interfering carrier, within the spectrum space normally occupied *by only a licensed television broadcast* transmitter. More about this function later.

The exact frequency, or the best information you can gather about the approximate frequency, is our starting point in tracing down an offending signal.

If we accept the fact that our interference is coming from a licensed transmitter, then we also accept the fact that the licensed transmitter is operating either on a *specific licensed frequency*, or, in the case of a citizens band or amateur radio station, within a licensed *band of frequencies*.

So if we can deduce *the frequency of our interference*, we can divide (or multiply) it around until we end up with one (or several) possible transmitter frequency which should suggest to us some *specific transmitter* as the culprit.

A few examples follow:

(1) We have a carrier causing a beat on channel 2 off the air. After some searching, we find a carrier on 54.470 (.780 MHz *below* channel 2) on our channel 2 downlead going into the channel 2 processor equipment. When it goes away, so does the beat in our picture. What is it?

Half of 54.470 is 27.235 MHz, a frequency authorized for the Class D Citizens Radio Service. On inspection we find a suspicious looking antenna on a house one-third mile away and out in front of our channel 2 antenna. A visit to the house reveals a CB operator lives there. And he admits transmitting on 27.235 MHz. How could this happen? Is the CB'er legal?

His transmitter was a five watt input power limit according to FCC rules. But, he has taken it upon himself to "modify" the transmitter by *taking out* a "funny little tuned circuit in the output circuit" because some other CB'er told him that circuit was robbing him of transmitter output power. What was that funny little tuned circuit in the output?

It was the *manufacture-installed harmonic filter*, the one that originally tuned out any illegal radiation at 2x his operating frequency!

End of the example? No, not quite. Because not only is 2x 27.235 MHz equal to 54.470 MHz (our channel 2 problem), but 3x 27.235 MHz is 81.705 MHz, which falls only 0.045 MHz away from the channel 5 aural carrier frequency of 81.750 MHz. While you have been experiencing beat (herringbone) pattern on channel 2 picture, you have also been experiencing *fade out* or *drop out* on channel 5 sound, which is exactly what would happen if your channel 5 processor suddenly had a strange carrier show up just 0.045 MHz away from the desired channel 5 audio carrier. That 0.045 MHz away carrier was strong enough to "capture" the aural carrier AGC on your processor. Bingo - two problems solved at once!

Another example:

(2) You have been using channel 8 from a 90 mile distant station for years. Then one day a beat or herringbone shows up in the picture. You try changing out the pre-amp. No dice. You try trapping around but the only time the beat goes away is when you have the trap tuned to channel 8 visual carrier; or perhaps just a shade higher in frequency. What is it?

You didn't pay much attention to the news item, but the local Junior College recently put a new educational FM transmitter on the air. No big deal, just a couple of hundred watts ERP from a little 100 foot stick more than a mile away. But, they are operating on 91.1 MHz and 2x 91.1 MHz is

182.200 MHz, which falls right square into channel 8.

Now the FCC rules say that their second harmonic radiation must be at least 80 db below their couple of hundred watts on 91.1 MHz. So you "borrow" a spectrum analyzer from the friendly TekTronix salesman and plug in your search antenna (an allband job). You tune up their 91.100 MHz signal and adjust it for full scale. Then the 182.200 MHz signal is found . . . and guess what? It is only 45 db below their 91.100 MHz signal! Not a sufficiently accurate measurement to justify citing them for a FCC violation, but all of the ammunition you need to march down to the local JC and have a "talk" with the professor responsible for running the transmitter (in hopes of getting it fixed).

These are "simple" problems. Not for the guy with the problem, but to figure out the cause.

However, they are not all this easy. So far we have looked at harmonics, or 2x, 3x, 4x etc. multiples of the transmission frequency, and given adequate data as to the approximate frequency of the interfering carrier, most anyone can divide by 2, 3 etc. to see what happens.

Recall that in our example channel 2 transmitter 9.208333 MHz was the *oscillator frequency*, and that the transmitter designer multiplied first by 2, and then by 3 to arrive at 55.250 MHz. The process is similar for most transmitters. Not all multiply by 2 and then by 3, but all start low and go up. Multiplications are usually done in 2's and 3's (2x, then 3x, or, 3x and then 2x) or some combination such as that. At transmitter stages 1/2 or 1/3rd of the final transmitter frequency several watts of power are often developed by the multiplier stages.

As an example, let's take a look at a common piece of aircraft electronics equipment that ends up transmitting around 400 MHz. The power output of the 400 MHz transmitter is on the order of 200 watts. The transmitter multiplier chain, to develop 200

watts at 400 MHz, also develops nearly 30 watts at 200 MHz (1/2 frequency). Now this is supposed to be *bottled up* inside of the well shielded transmitter case, but if in the course of routine maintenance a technician forgets to place a metal cover back on the 200-400 MHz *double circuit*, or the metal shielded lid is placed back on the transmitter housing improperly, the transmitter doubler operating at 200 MHz with 30 watts of 200 MHz RF power can easily radiate sufficient signal to cause interference at 200 MHz several miles away. In this case it may be necessary to *divide* an output frequency of a transmitter source for the interference you are experiencing.

Then there is a problem that is fairly common in the FM broadcast service, *especially* with older (1950-1960 vintage) transmitters. To develop 5-10 kilowatts of transmitter power at 88-108 MHz, many of the FM transmitters of that era use two tubes in the final output amplifier. To maintain *stability* of the final (power) amplifier, the tubes are *neutralized*, a term that describes the manner in which the tube(s) are maintained in a stable operating condition. The neutralizing adjustment gets out of whack quite on its own as tubes age, and as these older FM broadcast transmitters pass from hand to hand (station to station), it often happens that the transmitter goes into service in the hands of an *engineer* who is not aware of the tricky neutralization adjustment requirements. (This can happen with brand new FM band transmitters just as easily, although because it is a maintenance thing, it usually shows up in older units first.)

When this occurs, the FM transmitter amplifies not only its intended output frequency, but the final power amplifier also generates (or creates) relatively high output signals *several MHz away* from the main carrier. A recent case of a 91.7 MHz 100 kW educational FM station experiencing this problem produced strong signals within 0-15 miles of the transmitter every 1.6 MHz above



Basic picture with no interference



VCF	VCF	ACF
	ZERO BEAT	CCF

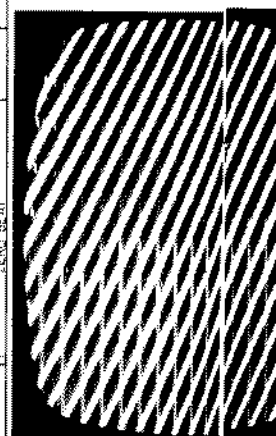

RFI PATTERNS

The off-screen photos in this group depict the degree of interference found when the interfering carrier signal is equal to the visual carrier level. The display below each photo shows the location of the interfering carrier, and relative level of the carriers within the passband. Note that as the interfering carrier moves up (or down) in frequency away from the visual carrier frequency, the degree of picture wash-out is reduced. See text for explanation of interference and effects of reducing level of interfering carrier. All photos are of an off-the-air (channel 2) signal with a locally generated CW signal (interfering carrier) mixed at the receiver input.

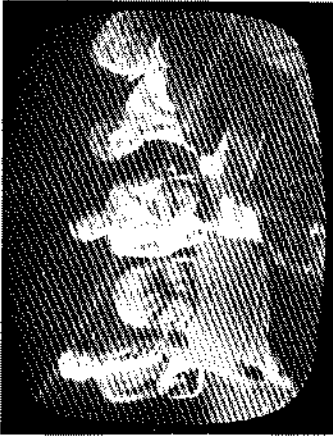

VCF	VCF	ACF
	+ 2.0 MHz	CCF



VCF	VCF	ACF
	+ 2.0 MHz	CCF

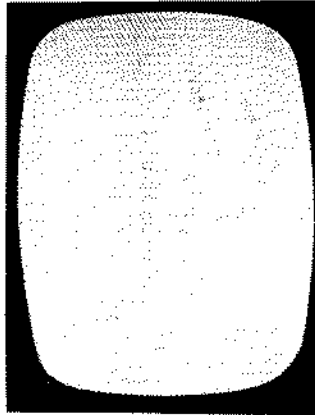

VCF	VCF	ACF
	+ 1.0 MHz	CCF



and below the 91.7 MHz carrier frequency. One of these landed on 88.5 MHz and another on 86.9 MHz, bracketing channel 6 aural at 87.75 MHz. The CATV system in the town had degraded audio, and weak *multiple* herringbone beat patterns on the channel 6 picture because of these *spurious* signals occurring on 88.5, 86.9, 85.3, 83.7 and 82.1 MHz. The educational FM broadcaster was quick to solve the problem *once it was brought to his attention*, but the CATV system lived with the problem for several days before they figured out what was happening.

This can happen with *any* transmitter, but high power transmitters are most apt to have this occur; and a high power transmitter in the hands of relatively inexperienced personnel is especially suspect.

Not all interference sources can be traced to the TV spectrum itself. In situations where the CATV system is utilizing hetrodying signal processors, the IF region between 39 and 45 MHz can also be a source of trouble.

Recall that in a hetrodyne signal processor, the input channel (call it 2) is *mixed* from one channel to the IF range where the signal is processed. Then the processed signal is mixed back up to a TV channel (call it 2 again).

While the TV signal is down inside of the hetrodyne processor, in the IF (*intermediate frequency*) range, a signal can get *into* the system operating on its proper output frequency (between 39 and 45 MHz) and do direct interference to the TV signal *while it is being processed*.

The 39-45 MHz region is primarily occupied by private and public safety two-way radio transmitters, most of which have short on-duty cycles. These transmitters come on for a short period of time, transmit a message, and then go off.

The most powerful transmitter systems in this range are usually those operated by state police systems. State police systems

(Continued on Page 27)

HOW HETRODYNE WORKS

Hetrodyne receiving systems began in the 1930's. Virtually all receivers in use today (AM, FM TV) are designed around the hetrodyne principal.

In engineering language, the incoming signal (say channel 2) is "hetrodyne'd" to a *new frequency* (intermediate frequency, abbreviated IF) where it is amplified, filtered, AGC'd, and then re-hetrodyne'd back to an outgoing frequency (say channel 2).

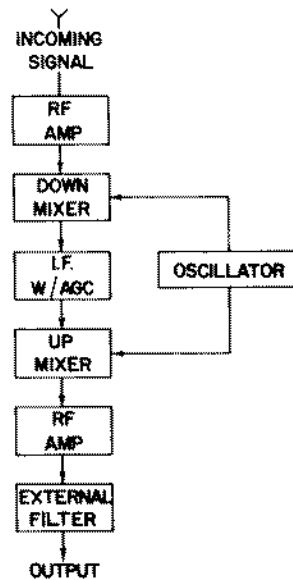

In the process of being processed, a TV channel (say 2) has two opportunities to pick up interfering carriers in a hetrodyne system; once at its incoming channel (say 2), and once at its IF (39-45 MHz roughly). And, if the outgoing frequency (say 7) is different than the incoming frequency, then it now has a third opportunity to pick up interference from other undesired carriers.

The diagram illustrates in block fashion how this occurs.

often seek the same type of hill or mountain top sites as CATV receiving systems, so common sites for CATV head ends are to be avoided.

Determining if a transmitter is getting into your TV channel(s) directly through the IF path of the heterodyne processor is quite simple:

(1) Place a TV receiver at the input to the processor so you can see the picture delivered by the antenna.

(2) Place another one at the output processor.

If the picture going into the processor is clean, but the picture coming out has herringbone beats in it, the interfering carrier is getting into the system at the IF range. Remember the interfering carriers that might get into a heterodyne processor (IF) do not

have to come from a regular transmitter.

Recall that initially we spoke of licensed and unlicensed transmitters, noting that unlicensed transmitters would include those that their owner/operators *know* are transmitters, and those that their owner/operator are not even aware are transmitting. Right inside of your head end are several of the latter!

Any circuit with an oscillator in it (crystal controlled or "free running") must be termed a transmitter, for our purposes here. Therefore, the following units are capable of creating carriers (and interference) right there in your head end:

(1) Any heterodyne processor uses a crystal controlled oscillator to mix and create the heterodyning process, or two crystal controlled oscillators if the input channel is one

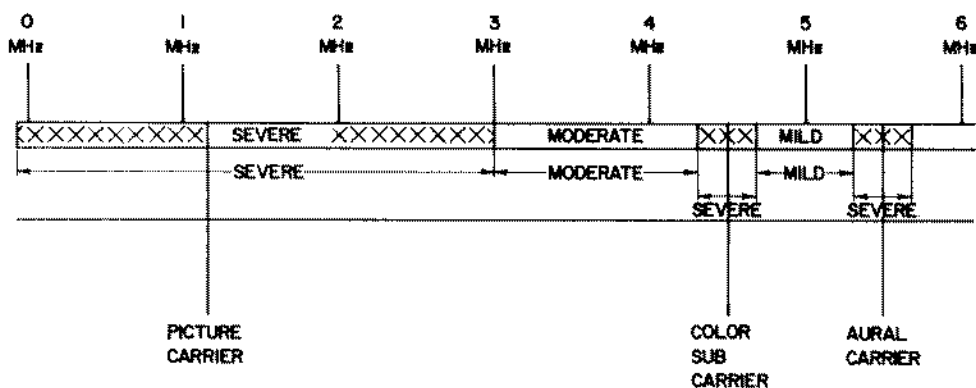

This diagram shows the degree of interference to be expected with undesired carriers falling into the desired channel passband. A carrier (undesired) falling into the *severe region* is most likely to cause herringbone (beat) to the picture. A carrier would have to fall within approximately 20 kHz of the actual picture carrier to produce horizontal lines (similar to co-channel interference). More than + or - 20 kHz away, the beat bars become "squiggly lines" that tend to slant across the screen in meandering fashion. These lines appear to *shimmy* as the interfering carrier is modulated (AM) or its frequency varied (FM). A carrier falling into the *moderate region* can be as much as 20 db weaker than a carrier falling into the *severe region*, and still not cause objectionable beating. A carrier falling into the *mild region* can be as much as 40 db weaker and still not cause the interference that a *severe region* carrier would. However, a carrier falling into color region (3.58 MHz above the picture carrier of the TV signal) can drive the color nuts or even key the color on when no color is being received from the TV signal! The region around the aural carrier frequency (+/- .250 MHz of same) is also a very severe region for interfering carriers.

channel and the output channel is another channel.

(2) *Any standby carrier* uses a crystal controlled oscillator to substitute for the TV picture carrier when it leaves the air or input to the system.

(3) *Any FM conversion unit* uses one or more crystal controlled oscillator(s) to process FM signals either singly or as a group from their input frequency down to an IF and then back up to a cable output frequency.

(4) *Any pilot carrier generator* uses one or more crystal controlled oscillator(s) to generate the 73, 165, 220 MHz (exact frequencies vary with different units) cable carried pilot carrier reference signals.

(5) *Any microwave receiver or transmitter* uses one or more crystal controlled oscillator(s) to generate microwave to video RF conversion (in receiver) or video to microwave RF conversion (in transmitter).

(6) *Any modulator* uses a crystal controlled oscillator to generate the RF carrier output signal on the TV channel.

(7) *A marker generator* uses multiple oscillators rich in harmonic output to generate marker-carriers for test purposes.

(8) *A sweep generator* uses a non-crystal controlled oscillator to generate the sweep bandwidth, which may be run in the "CW" (continuous wave) or narrow frequency by the operator.

(9) *A field strength meter* uses a tuneable oscillator to produce an IF, which is where detection takes place.

(10) *A television receiver* uses a preset but fine tuneable non-crystal controlled oscillator to produce the beating effect required to convert a VHF or UHF TV signal down to IF.

(11) *A color TV receiver* uses a 3.58 (3.579 etc.) MHz crystal to generate the CW carrier required for recovery of the TV color information.

(12) *An FM tuner/receiver* uses a tuneable non-crystal controlled oscillator to pro-

duce the *beating* effect required to convert a 88-108 MHz input signal down to the standard 10.7 MHz FM IF range.

These are all very real sources of RF interference in a CATV head end, often right there in the same rack(s) as your TV processing equipment!

It is a compliment to industry engineering that we do not have more problems with RFI (radio frequency interference) than we do, and a tribute to the careful design of *all* oscillators, multipliers and amplifiers that more energy does not *leak* out of oscillators and multipliers and into receivers or processing equipment.

None the less, due to misadjustment, operator error, or faulty design, any of these TV oscillators and their multipliers can be sources for RFI. The procedure in tracking down these in-house interference sources is routine. Start by selectively turning off and on every potential source of RFI in the head end, watching to see which unit has been turned off when the interference goes away.

Then approach the oscillator and multiplier chain *in the offensive unit* logically; perhaps it was serviced recently and some *changes* were made, or a shield was left off an oscillator or multiplier. Perhaps in re-assembling a unit down for maintenance someone put in two screws to hold a shield in place, where the manufacturer had 16 screws! All of those screws on a shield have a purpose, they keep oscillator energy bottled up *inside of a box*.

Several tips for tracing in head end radiation are given elsewhere in this article.

Trap/Sbunts

Once an interfering carrier is part of the TV carrier spectrum *in a processor or receiver* the damage has been done. That is, once the desired signal and the undesired signal have gone through an amplifier (any amplifier including a pre-amplifier) *together*, there is no way known to man to extract the undesired signal from the desired signal with-

WHERE HARMONICS/MULTIPLES FALL AT VHF

Carriers generated at frequencies below the TV channels often appear as harmonics or multiples of multiplier stages in the VHF ranges. This table locates these sources.

	27 MHz CB	28-30 MHz Ham	30-36 MHz Two-Way	36-40 MHz Two-Way	40-45 MHz Two-Way	45-50 MHz Two-Way
2	2x (pic)	2x (pic) 2x (aural)				
3			2x (pic) 2x (aural)			
4			2x (pic) 2x (aural)	2x (aural)		
5	3x (aural)			2x (pic)	2x (aural)	
6		3x (pic) 3x (aural)			2x (pic) 2x (aural)	
7		5x (pic) 5x (aural)				
8			5x (pic)	5x (pic) 5x (aural) 5x (pic) 5x (aural) 5x (pic) 5x (aural) 5x (pic)		
9	7x (pic)					
10		7x (pic) 7x (aural)				
11					5x (pic) 5x (aural)	
12					5x (pic) 5x (aural)	
13			7x (pic) 7x (aural)		5x (pic) 5x (aural)	
1F				direct	direct	direct

out doing damage to the desired signal in the process(*).

The proper place to trap an offending carrier is at its source. If that is in your head end, the job is relatively simple. First locate the offending unit, then determine the exact output point from the unit which is causing you the problem. If the offending point is directly out of an oscillator or multiplier, you can either go into the circuit and try to tame the radiation, or shield the radiation source with a metal shield so that it no longer radiates strongly enough to cause interference.

If the radiation is getting through to the output of the unit (even though the frequency of the interfering radiation is *different* than the output frequency of the unit),

you can install a simple trap on the output of the unit to filter out the offending energy.

Remember the harmonic filter on the broadcast transmitter? You can design one of your own to go on the output of your offending unit. The filter (or trap) can operate on the frequency of the offending carrier (whether that is *lower or higher* in frequency than the desired output of the unit) as long as the frequency involved is *not* the intended output frequency of the unit. If the intended output frequency of the of-

(*Systems that demodulate off-the-air video to baseband (video) can do some filtering tricks with in-band interference problems (witness at video co-channel filters), but RF processors cannot do this.)

CHECKING CARRIER SOURCES FOR RADIATION

If it is believed that a lower level stage of a transmitter, or an oscillator or multiplier stage in a head end piece of carrier generating gear is radiating on a TV channel frequency, follow the procedure shown here. Tune an FSM/SLM to the frequency of the offending carrier and remove all internal attenuation from the FSM/SLM (i.e. place in its most sensitive range). Connect a length of RG-59/U cable to the FSM (keep this length to a few feet) and bare back 6-8 inches of the center conductor as shown; bend into a two turn loop and solder to the shield as shown. This loop makes an RF probe which you can use as an "antenna" to probe around on the suspect-unit to look for an indicated carrier. When you find a hot spot for the carrier on the unit in question, you know where the radiation may be coming from, and can start shielding appropriately.

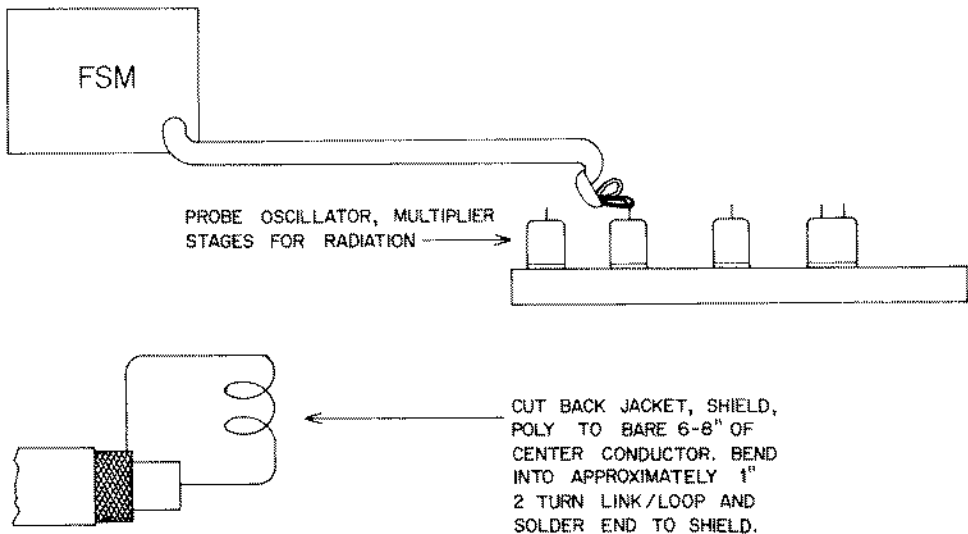

fending unit is the *same frequency* (direct, not harmonic or multiplier) as the problem input frequency on your TV channel, it can't be successfully trapped at the source, because the source is *the source!*

The best cure for this problem is isolation, physical separation between the two units and careful shielding of the high energy output of the interference source from the relatively low level input of the TV signal processor. Often moving a unit such as this to the "far end" of the head end and shielding the unit will solve the problem. Double shielded RG-59/U jumpers with equipment cases to earth grounds will also help when the signal is being transmitted around the head end on coaxial shields or the racks.

HEAD END CARRIER SOURCES

(1) *Hetrodyne Processor* — check frequency on crystal (stamped on crystal); multiply by 2x and 3x and 5x frequency for potential beats in other channels. Note: If input channel is different from output channel, there are two crystals involved; check them both.

(2) *Standby carriers* — check frequency stamped on crystal. If a low band unit, frequency should be the same as the TV picture carrier frequency. If a high band unit, frequency stamped on crystal is usually $\frac{1}{2}$ or $\frac{1}{3}$ of the actual TV carrier frequency. Multiply low band crystals by 2 or 3 for harmonics; if high band crystals are $\frac{1}{3}$ rd of TV carrier frequency, multiply by 2 for unwanted harmonic.

(3) *FM conversion units* — this is a hetrodyne unit; follow same procedure as with TV hetrodyne units.

(4) *Pilot Carrier Generator* — low band 72-76 MHz carriers usually operate at the frequency stamped on the crystal. Mid-band (165 MHz) carriers usually operate at 2x the crystal frequency. High band carriers usually operate at 3x the crystal frequency.

(5) *Microwave receivers* — essentially a hetrodyne type of receiver; follow procedure as with hetrodyne CATV processors. NOTE: More than one conversion is often employed; check for two or more

crystals, and oscillator and multiplier chains.

(6) *Microwave transmitters* — locate crystal, and note frequency. Start multiplying by 2x,3x,5x and 7x to see where you land in the VHF TV spectrum.

(7) *TV channel modulator* — locate crystal; multiply by 2x,3x,5x and 7x to see where you land in the VHF TV spectrum.

(8) *TV, FM receiver, FSM* — all have non-crystal controlled (i.e. tuneable) oscillators. Change channel, tuning.

NO ANALYZER?

Tracing down an interfering carrier without a spectrum analyzer can be a problem. One technique is to utilize an external signal generator as shown in the diagram below to mix or beat with the incoming interfering carrier. As you tune the signal generator around within the TV passband, you will find a *zero-beat* condition between the signal generator carrier and (a) the TV visual carrier, and, (b) the interfering carrier. A frequency counter, as noted, would help to pin down the actual frequency of the nondesired carrier when the TV screen shows a zero-beat condition.

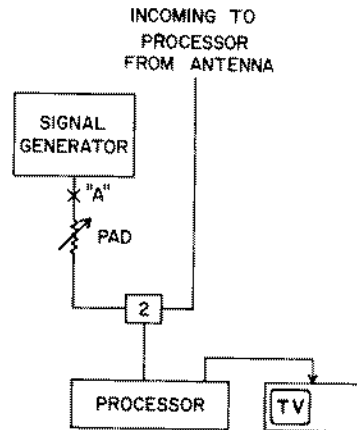

"A" — BREAK HERE TO INSERT 2ND. 2-WAY SPLITTER TO DRIVE FREQUENCY COUNTER.

CATJ MARKER GENERATOR

If CATV has entered a new era since its 21st birthday, it is probably the *test equipment era*. As our systems have grown more complex, and the FCC has instituted system operational standards and specifications, the requirements for tests . . . *accurate tests*, have risen. So *too* have test equipment prices.

Ten years ago a system operator could *get by* with a Jerrold 601-D sweep test, detector, and a handful of other instruments including an FSM and a VOM. This is no longer true.

Even the system with these basic pieces of equipment (and many still labor along *without* even these) is going to have to face up to the fact that before 1977, even the oldest, most antiquated system is going to be forced into modernization and a position of ability to maintain a system that will meet FCC specs.

To greet this not so far away eventuality, CATJ is dedicating itself to publishing a series of articles on do-it-yourself test equipment. This will be test equipment which *you can build* from scratch, yourself, on your own bench, in your own time. There will be one complete piece of test equipment each month; or a major section of a more elaborate unit.

Each unit described will be adequately detailed so that you can either (1) procure the parts on your own and build it up, or, (2) order a complete set of parts from a supplier of electronic kits. (*)

Crystal Marker & Generator

Having a good, moderately high level output, marker generator on your test bench or in the field is one of the handiest things you can do.

by
Steven K. Richey
Richey Development Company
Oklahoma City, Oklahoma

If you have a sweep system, you already know the value of having markers; they tell you *where you are*. But if you had a marker source external from your sweep, you could also perform many other system tests.

Basically, a marker is nothing more than a carrier generator; usually crystal controlled on a specific frequency or a basic frequency plus harmonics thereof.

If you plug the marker into your sweep system, as an external (i.e. non-sweep package) marker, you can produce *marks* on your sweep display at the precise points which you require.

If you plug the marker into your system proper (see diagram 2), you can send throughout the entire system a carrier on the frequency generated by the marker. And this carrier can be very useful for determining some of the operational characteristics of your system.

Let's talk about just one of those characteristics at this point; *radiation*.

Radiation is an ugly word. In CATV, it means the transmission of a signal (or signals) from a seemingly secure inside-of-coax transmission medium to some point outside of that transmission medium, *in violation of the security (integrity) of the coaxial cable shielding*.

Or to put it another way, radiation is the terminology we use in this industry to describe a condition which exists, but which should not exist. A condition whereby our cable signals end up outside of the cable, being transmitted through the air *as well as* through the cable!

Under the rules and regulations of the Federal Communications Commission, radiation from our cable, fittings, amplifiers, directional and pressure taps — *in fact from anything in our plant* — is limited to the following max-

imum:

"from 54 to 216 MHz, 20 microvolts per meter at a distance of 10 feet".

In plain English language, that is darn little signal!

So little signal, in fact, that to make this measurement with a field strength meter or TV set and a dipole (*), we will more often than not run into that much signal and a whole lot more just *leaking in from television stations* in the area, even from stations that are too far away to use reliably on our cable distribution systems.

So one of the real perplexing problems presented to us, if we are to comply with Part 76.605 (a) (12), is *how do we really assure ourselves*, as we make measurements and maintain our systems, *that we are not radiating more than the prescribed maximums?*

If our on-cable channels are occupied by the same off-the-air channels, or if the off-the-air channels cover up our on-cable channels, determining which signal is coming from our lines and equipment (i.e. radiation) and which is coming in off-the-air can be a very painful, if not impossible thing to do.

But alas, like any good problem, there is a good answer.

If you build up this marker generator, you can plug-in at the head end (diagram 2) with the output of the marker, set it to the proper level, and at that point you have a carrier on the system (throughout the entire cabled community) which you can select to be on a frequency which is not occupied by an off-the-air signal.

Then you can take your dipole antenna (cut for the right frequency) and your FSM/SLM, and setting your FSM/SLM to maximum sen-

* — The Federal Communications Commission recently ruled that radiation measurements can be made, under certain conditions, with a portable TV receiver and a dipole antenna. Unfortunately, this technique cannot be employed in locations where *any* off-the-air television signals are capable of being received on the channels which you will be measuring with the portable receiver and antenna.

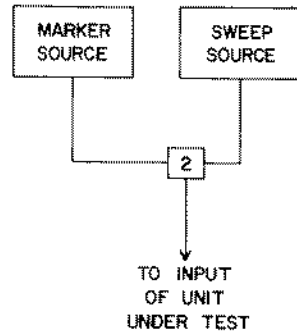

DIAGRAM ONE-A

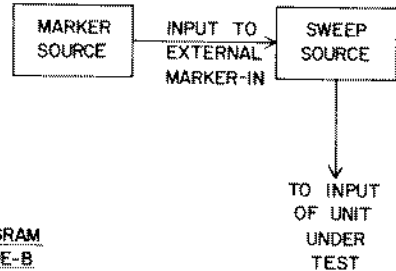

DIAGRAM ONE-B

sitivity, drive out the town looking for radiation on your *secure* frequency of your marker generator; as plugged into the system at the head end.

If you have a low band only system, you can select the marker-oscillator at 54 MHz (or even place it at 53 or 52 MHz, just *up in frequency* from the point where your low band only system starts to have amplifier gain fall off.) If you have a *low band plus FM system*, you can place your marker-generator oscillator on a frequency such as 109 MHz, right at the top of your amplifier pass-band in the plant.

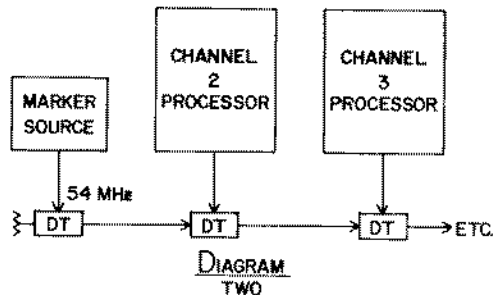

DIAGRAM TWO

If you have an all band system, you can activate two separate marker oscillators; one at 54 or 109 MHz and another at 170 MHz, and check for radiation at both the low end and the high end.

This month's construction project details a marker oscillator package that will house up to 10 separate discrete markers; you can incorporate one at a time, or several at a time, or all 10 at once.

The initial oscillators chosen for the project are as follows:

- (1) 39.75 MHz
- (2) 41.25 MHz
- (3) 42.17 MHz
- (4) 45.75 MHz
- (5) 47.25 MHz

These frequencies have been chosen for the system that uses heterodyne signal processors; in an early issue of CATJ we will detail alignment and trouble-shooting practices for one of the most popular heterodyne processors in use today; the Channel Commander One. Having markers to align this unit is a must-requirement.

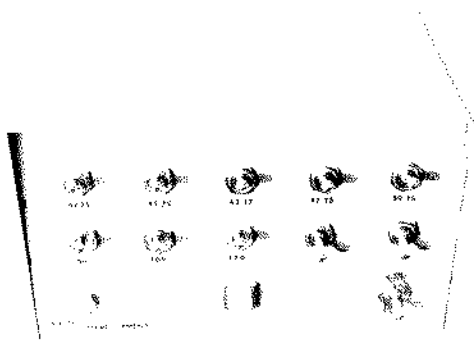

- Additionally, oscillators are covered for:
- (6) 54 MHz (for radiation and band edge marking)
 - (7) 109 MHz
 - (8) 170 MHz

Note that the master circuit provides for ten plug-in oscillators, operating in the 39-220 MHz region, so if you don't like the eight we have pre-chosen, you can add others or substitute at will.

Each marker is crystal controlled and turned on and off separately by front panel

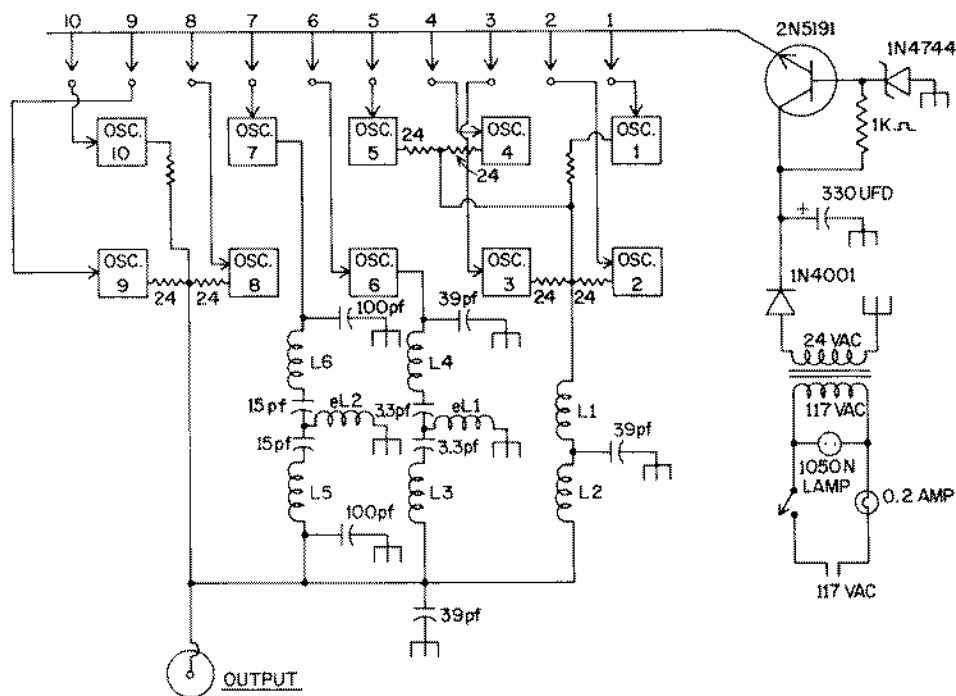

switches. Individual output level controls are mounted on each marker-oscillator board so you have a range of control over the individual marker outputs.

All marker-oscillators plug into a master or *mother board* which fits down along the bottom of the standard enclosure chosen. The mother board provides the RF (signal) mixing, isolation between oscillators so that tuning (or turning on and off) one does not interact with another one, and a common way to power each board (marker-oscillator) as it plugs into the sockets provided.

Once the mother board is completed, with the power supply and the case, you can add marker-oscillators as your needs dictate. That is, you need only spend the money for the markers you need as you require them. Start off with only one, if that is what you need. But the expansion is there for up to 10 individual oscillators when the unit is "full".

The unit has a well regulated power supply, and the output level through the front-panel F fitting is relatively high; +50 dbmv is typical.

Construction

Begin by mounting all of the hardware, switches and output connector, fuse holder, and so on. No hole template is given in this description, but one is provided with the parts kit should you decide to use the parts kit.

See figure one; this illustrates how the power supply transistor (2N5191) is mounted. Note that a mica insulator is installed between the transistor case and the metal container wall.

Power supply parts can be mounted on the container back wall as shown in the photographs. Exact locations are not critical, but long leads should be avoided in *any* VHF construction project; even in the power supply!

Now proceed to wire up the *mother board* in this sequence:

- (1) Place all of the called for resistors in place; and solder them into position.
- (2) Next place all of the disc ceramic capacitors in place, and solder them into position.

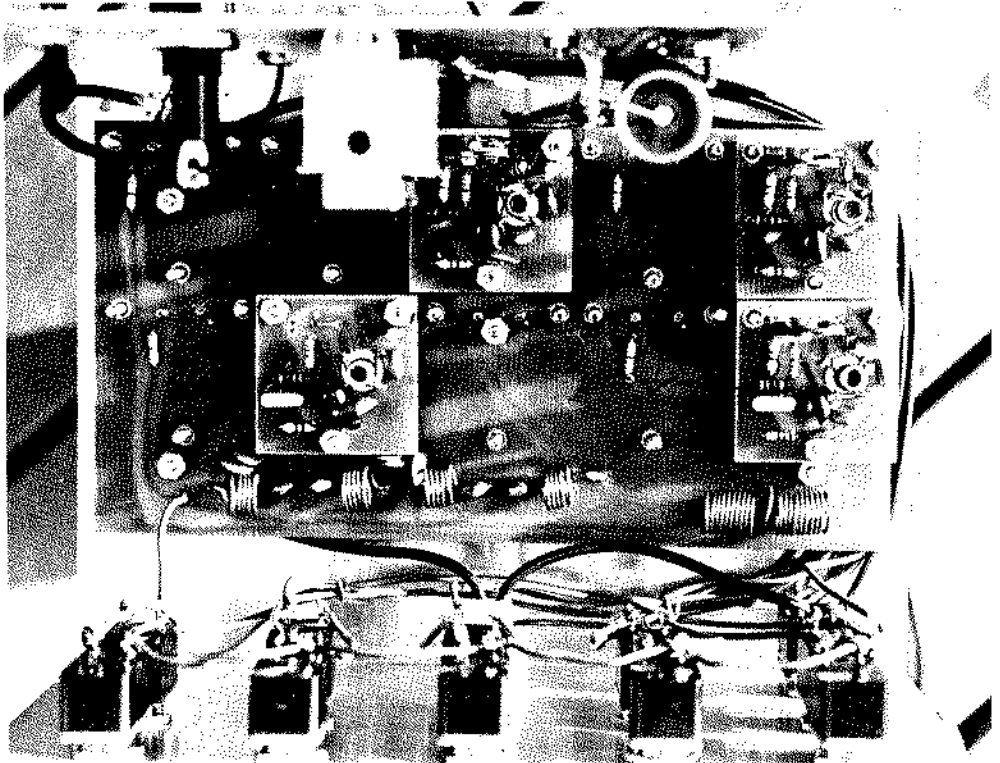

(3) Now place all of the coil inductors (L1—L6) into position and solder them into position.

(4) Next prepare all of your switch wires and solder them to their respective locations on the board. The ends to be connected onto the switches will be completed later.

(5) Now install the 4-40 x 3/4 inch screws into position at each oscillator plug in location (one screw goes on two corners, and a third in the middle of the opposite side, to hold the oscillator in place), and thread-on a 1/4 inch spacer. The spacer acts to keep the screw in place and it also provides a stand-off support for the oscillator boards to be added.

(6) Take one of the oscillators, noting that the pre-wired and tested oscillator boards available as a part of the kit offering have contact pins (two per oscillator board). Place a Molex connector over each pin, and then slide the oscillator board into position over the three 4-40 x 3/4 inch screws previously soldered into position.

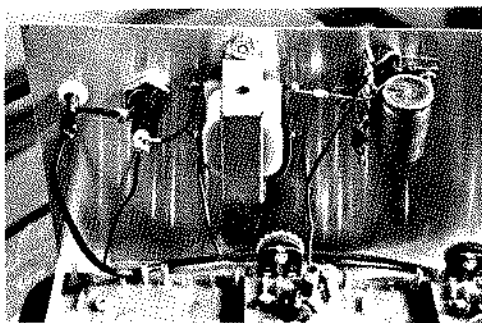

With the oscillator board *in position* on the mounting screws, the Molex connectors will protrude through the *mother board*. Turn the *mother board* over, and solder the Molex connector points to the board where they stick through.

Repeat the process for all of the ten oscillator positions; resulting in all ten positions being ready for boards to be "plugged in".

(7) Now mount the *mother board* to the chassis using 4-40 x 1/4 spacers and 4-40 screws and nuts.

NOTICE TO CATJ READERS

CATJ Over 7,500 copies of this issue of *CATJ* — the Community Antenna Television Journal — have been placed into circulation. You have one in your hands.

CATJ To introduce all members of the CATV and MATV systems industry to the benefits of *CATJ*, we are sending out thousands of *sample copies* of *CATJ* this month.

CATJ Is published by the Community Antenna Television Association . . . a non-profit trade association of people and companies who own and operate community (and master) antenna systems.

CATJ Will, eventually (and soon) be circulated only by mail to *paid subscribers*. That is, sample copies now being circulated to introduce *CATJ* to system owners and technicians will start being phased out in favor of paid circulation next month, with the June issue.

CATJ This may be your first (*and last*) FREE sample copy of *CATJ*. If you like what *CATJ* says and how it says it, the smartest thing you can do is to *turn now* to the subscription application card between pages 8 and 9 or 40 and 41, and send that form to *CATJ* today. That is the *ONLY* way *CATJ* can be guaranteed to be in your mailbox next month.

Complete either subscription application card or, if both cards are gone, send \$10.00 for a System subscription or \$7.00 for a Technician's subscription to *CATJ* today.

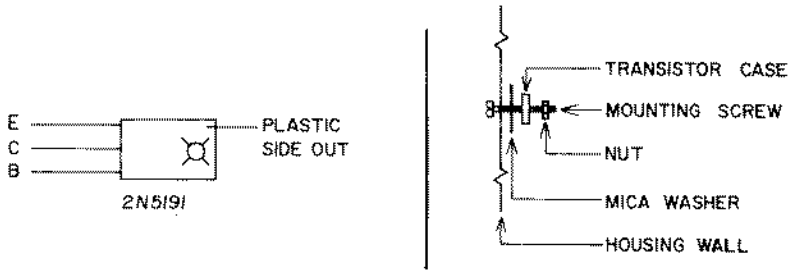

FIGURE 1

SPARE	109	39.75	41.25	47.25	
SPARE	54	170	42.17	45.75	

FIGURE 2 - MOTHER BOARD LAYOUT

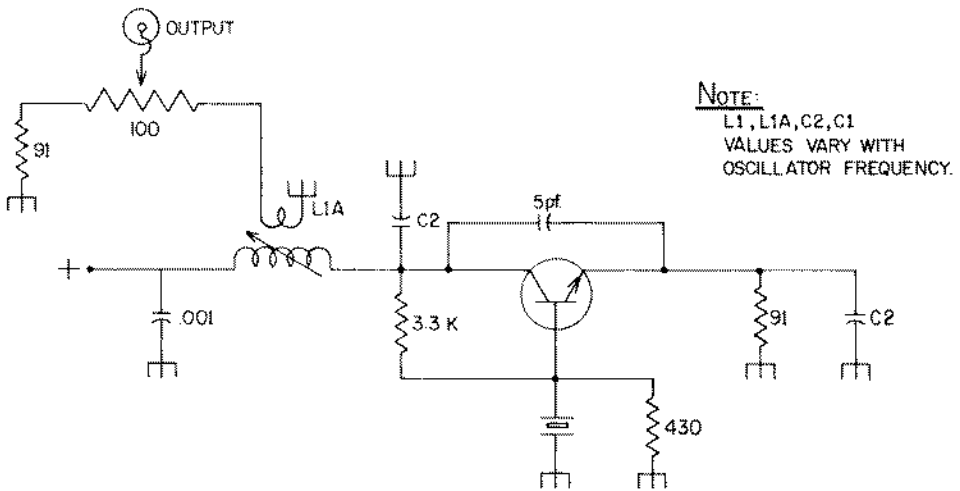
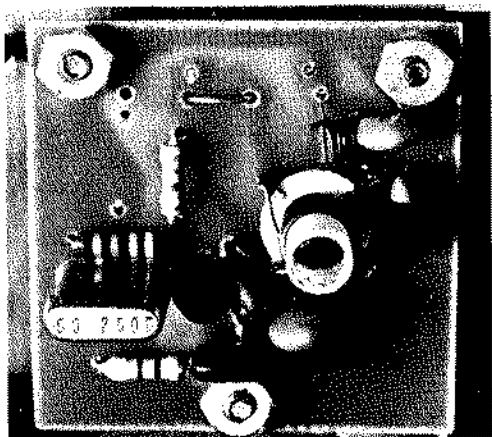

FIGURE 3



(8) Wire in the switches, noting which switch position goes to which oscillator board position (figures 2 and 4). Use an ohm meter to trace which wire goes to which oscillator, or if you are going to wire up the kit parts, the wires are color coded. Wires to each oscillator module connect to one side of the appropriate switch while the opposite side of the switch is wired in series with all other switches (figure 5) and then to the emitter of the 2N5191 (figure 4).

Wire up your pilot light and power switch (figure 4); and your unit is ready to test.

Adjustments

Marker-oscillator generator adjustments are very simple. Following the board layout in figure two, plug in your oscillator(s).

(All oscillators utilized with the kit procedure have been pre-constructed, and tested. If you follow figure 3 and construct your own oscillators, you will have to first test the oscillator to ensure that it is functioning properly, and is on frequency.)

Connect the output of your marker-oscillator unit to the *marker input* (external marker input) connector on your sweep system. If your sweep unit does not have an external marker input access fitting, follow the instructions given in diagram 1.

Set your sweep display so that you are approximately sweeping the region which your oscillators will mark.

Now turn on one marker-oscillator at a time and observe where it marks your sweep display. The 100 ohm potentiometer in the output leg of each plug in oscillator adjusts the level

of that marker. The markers can be adjusted for different output level ranges as follows:

(1) To adjust the output level of the 109 MHz marker, disconnect the marker-oscillator output from the sweep and reconnect it to your FSM/SLM. Turn on that 109 MHz marker and tune in your FSM to this carrier.

By inserting an insulated plastic tuning tool between the turns on coils L5 and L6, you can *peak* the output level (maximize) of the 109 MHz oscillator by spreading coil turns. It should peak at approximately +50 dbmv.

Turn off the 109 MHz marker-oscillator and repeat the coil spreading process for peak output level from the 170 MHz oscillator; by spreading the turns on L3 and L4.

The unit is now ready to use.

Other Uses

Few people realize how useful a low power (marker) oscillator can be. In addition to the service bench marking applications, and the source for radiation tests, a low powered signal source can be useful in antenna measurements. A future article will describe how this test oscillator and a simple antenna can be useful in phasing complex antenna arrays for co-channel elimination.

Placed into permanent service at the head end, on a frequency not in regular service, its stable operation will provide an excellent *reference signal* throughout the entire CATV plant for plant performance monitoring.

Next Month

Our series on test equipment construction will continue with the introduction of a 12 channel crystal controlled marker generator with 4.5 MHz and 3.58 MHz modulation.

(*) Kits or PC boards described in CATJ are available from a packager of kits through CATJ; to CATJ specifications. To order the kits described in this article:

Terms — payment with order.

Price — for complete kit of parts, PC board, housing and instructions for the Marker kit (but *less* any oscillators) — \$30.00 post-paid.

For any of the oscillators specified (39.75 MHz, 41.25 MHz, 42.17 MHz,

45.75 MHz, 47.25 MHz, 54.0 MHz, 109 MHz, 170 MHz) — \$15.00 each, pre-wired and tested.

Order — send order with payment to KITS, Community Antenna Television Journal, 4209 NW 23rd, Oklahoma City, Oklahoma 73107. Specify exact kit and oscillator required.

PARTS LIST - MARKER

- 1 - LMB chassis box, #685
- 11 - SPST switches
- 1 - 117VAC pilot light
- 1 - F61A connector
- 1 - power cord
- 1 - fuse holder
- 1 - fuse (3AG, 0.2 amp)
- 1 - 24 VAC secondary, 117 VAC primary power transformer Radio Shack #273-1386
- 1 - 5 position terminal strip, center grounded
- 1 - 1N4001
- 1 - 1N4744 zener
- 1 - 2N5191
- 1 - 330 MFD at 64 volt electrolytic
- 1 - 1k ½ watt resistor
- 8 - 24 ohm, ¼ watt resistors
- 2 - 100 pf ceramic caps
- 2 - 3.3 pf ceramic caps
- 3 - 39 pf ceramic caps
- 2 - 15 pf ceramic caps
- 46 - 4-40 x ¾ bolts
- 46 - ¼" spacers 4-40 threaded
- 20 - Molex connectors
- 1 - solder lug
- 4 - 4-40 nuts
- 1 - plastic grommet

**More than superior equipment—
a way to
optimize profitability
in your Cable TV system**

Magnavox
catv division
measures up!

BUILDING AND ERECTING TOWERS IS MAN'S WORK

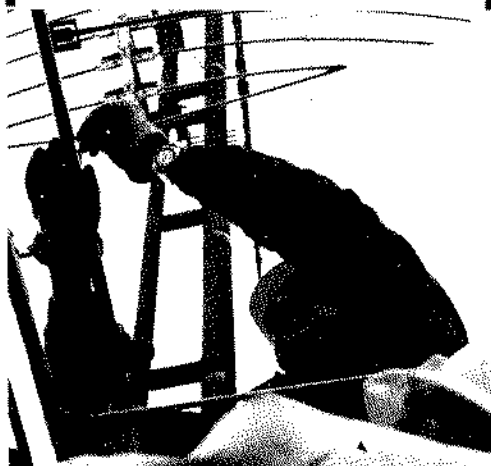

Stormy Weathers — Experienced

And one man in particular has been providing high quality CATV and broadcast towers throughout the Midwest and East for more than 20 years; "Stormy" Weathers is that man's name.

U.S. Towers — Quality

United States Tower & Fabricating Company is Weathers' company. A man like Weathers is judged by the work he does. U.S. Tower has fabricated and installed CATV towers from 100 feet up, up to 44 inch face. Quality towers that are rugged, precision constructed, and built to hold even the largest quad and stacked arrays with plenty of safety margin.

U.S. Towers — Save \$\$\$\$

U.S. Tower can save you money on your next tower; as much as \$10.00 per installed foot on a 500 foot super-strong stick with star mounts. And U.S. Tower will handle the complete tower job, including hanging antennas, pre-amps and running downlines!

Special Small System Tower

Ask about the newly designed 18 inch face heavy-duty CATV small-system tower designed to go to 300 feet with up to 12 channels of CATV logs / yags; in 12 foot sections for easy self-erection!

**U.S. TOWER & FABRICATION
COMPANY**

**P.O. Drawer "S"
AFTON, OKLAHOMA 74331
(918) 257-4351**

SINGLE ENDED LINE EXTENDERS

The Transistor

One of the first problems a CATV design engineer must cope with when designing a single ended CATV line extender is the inherent gain v.s. frequency response of the transistor. See figure one.

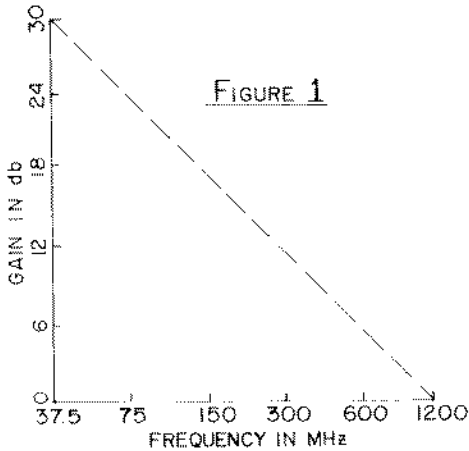

FIGURE 1

Most transistors used in CATV amplifiers have what is known as a 6 db-per-octave gain decrease; that is, if the gain of the transistor is zero (0) db at 1200 MHz, the gain of the transistor one octave lower (600 MHz) is 6 db, at two octaves lower (300 MHz) 12 db, and so on

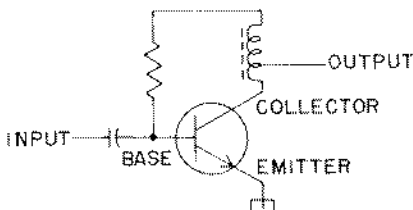

FIGURE 1-A

down to zero frequency. This is far from being a *flat-amplifier* device! So before the engineer can start any serious design work, he must *flatten* out the gain of the transistor.

The most common way to do this is with feedback (see figure two).

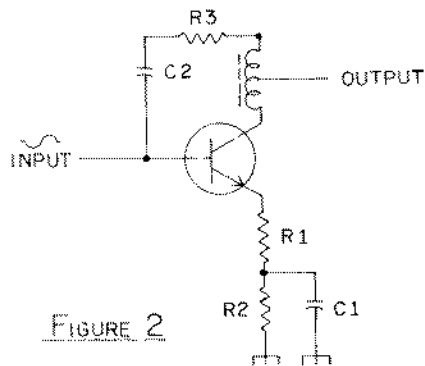

FIGURE 2

The transistor in figure 2 is using two separate types of feedback; current feedback (or emitter degeneration) and voltage (or collector-base) feedback. Notice in figure 1A that to achieve the gain-curve plot of figure 1 that the emitter is at both AC and DC ground potential. By raising the emitter off of DC ground with R2 (in figure 3) but maintaining it at AC ground with C1 (figure 3), we will not change the gain of the stage from figure 1A.

However, if we add a resistor between R2/C1 and the emitter, (R1 in figure 2) we will *lower* the amplifier gain. And because the gain of the amplifier is greater at the lower frequencies the gain reduction caused by inserting R1 into the circuit will be greater at the lower frequencies than at the higher frequencies; this is called *emitter feedback*.

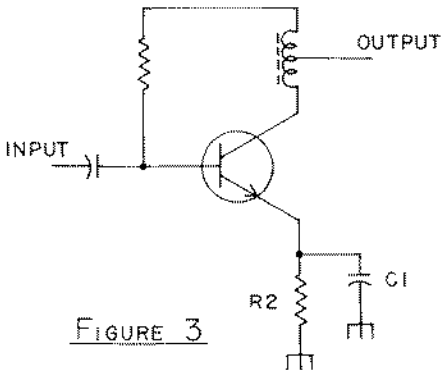

FIGURE 3

The second form of feedback employed here takes advantage of the fact that in a common emitter amplifier design the output is 180 degrees out of phase with the input (see figure 2). And by feeding a portion of the output signal back into the input (through R3 and C2) the signals cancel. And once again because of the higher gain at the lower frequencies, cancellation is greater at the low end. The size of resistor R3 governs the amount of feedback. Use of the two types of feedback (one or both) can be used in designing flat stage gain, or a low end tilted response.

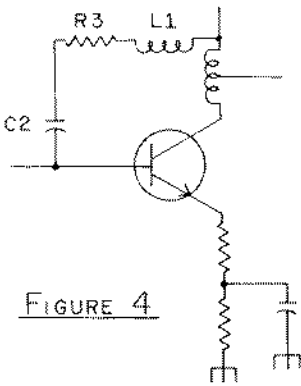

FIGURE 4

If an inductor (L1 in figure 4) is added, the amount of feedback at higher frequencies is decreased. This is caused by the reactance (AC resistance) of the inductor at the higher frequencies; and this gives the maximum amount of gain for the stage at the higher frequencies.

Other Compensation Methods

Figure 5 shows another compensating method for inherent transistor non-linearity in

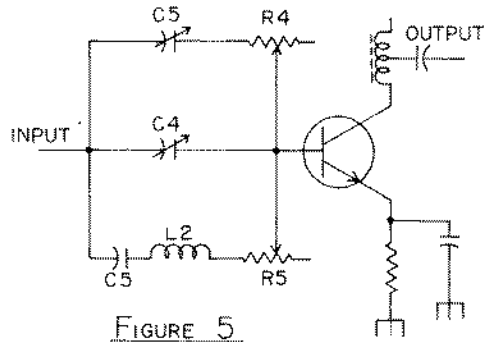

FIGURE 5

the gain mode. This circuit *pre-distorts* the input bandpass response so that a signal (range) that arrives at the amplifier input essentially flat from 50-300 MHz is tilted in the pre-compensation network. Then the non-linear gain of the transistor stage takes over, resulting in the output being flat after amplification.

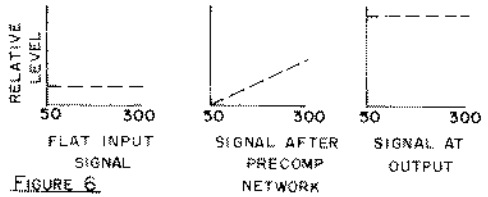

FIGURE 6

Yet another method found in CATV line extenders is shown in figure 7. The input signal is coupled through C1 to the network of L1/R1, where some of the low end signal response is shunted to ground. This is a form of *pre-compensation*. L1/R1 also assist in matching the input of the transistor device to 75 ohms. The signal is then coupled through transformer T1 and capacitor C2 to the base of the transistor for amplification.

C5 and R4 control the mid-band response; C4 controls the high frequency end and C3, L2 and R5 control the low end. Notice the absence of any feedback network.

In the emitter circuit, R3 is there strictly for biasing; a subject to be discussed shortly. R4

is usually about 30 ohms and C3 is .001 or larger; thus forming some emitter feedback. C4 and R5 are for adjusting the mid-band gain while C5 is for high end peaking. Capacitor C6 is a form of positive feedback used on occasions; usually a 5-10 pF disc that also peaks up the high end response.

the base of the transistor. This places forward bias on the base/emitter junction. It should be noted that the resistors used here are usually quite small in value (especially R2); this is done to create a bias condition which is independent of the base current. This promotes stable DC operation.

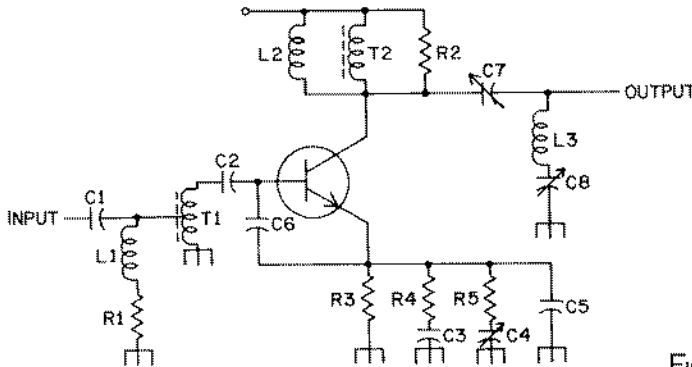

FIGURE 7

In the collector the signal is coupled out through transformer T2 which has a small value low-Q inductor (L2) across it. This inductor swamps the low frequency end down; and resistor R2 does the same thing, to retard the low frequency gain.

C7 couples the output signal to the next stage; its value is chosen typically to have high reactance at the low frequency end which forms a type of post-compensation loss for the low frequency end once again. Finally C8 and L3 form a very broad low Q trap which is again in place to control the low end gain.

Biasing

CATV transistors are biased in a fairly conventional manner; in figure 8 R1 and R2 form a voltage divider network applying voltage to

The voltage appearing at the base can be approximated by the following formula:

$$\frac{R2}{R1 + R2} (V_{cc}) = \text{base voltage}$$

So if:

R1 = 3.3 k

R2 = 680 ohms

Vcc = 20 volts,

we get:

$$\frac{680}{3300+680} (20) =$$

$$\frac{680}{3980} (20) =$$

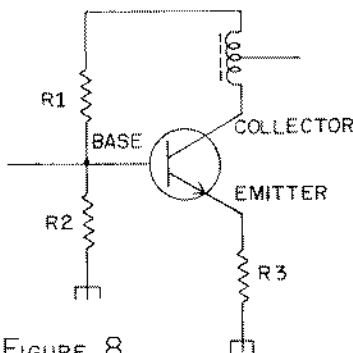

FIGURE 8

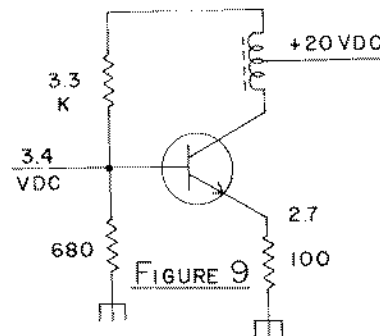

FIGURE 9

.17 x (20) = 3.4 volts on the base, of the transistor. An NPN transistor has a voltage drop of 0.7 volts across the base-emitter junction. So we can then deduce that the correct voltage at the emitter would be approximately 2.7 volts (3.4-0.7). So if the emitter resistor is 100

ohms, we can use ohms law ($I = \frac{E}{R}$) and

substituting in the known values, $I = \frac{2.7}{100}$ we

find our collector current is 27 mA. Following this same procedure for trouble shooting NPN line extender circuits should allow you to pin down faulty stages that have voltage problems.

Gain Controls

The most common type of line extender gain control is a simple pot on the input circuit (see figure 10). This circuit provides a fairly constant impedance match to the input but its disadvantage is that it varies the output match somewhat.

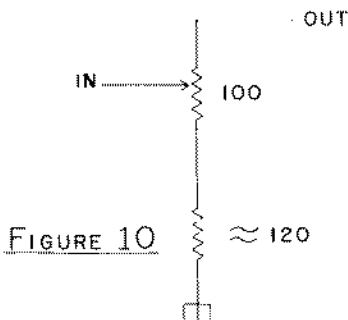

FIGURE 10

Other types of gain controls used are trimmer capacitors located inter-stage (between gain stages), as shown in figure 11. This

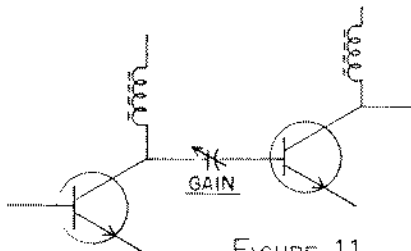

FIGURE 11

capacitor varies the coupling between stages and is used extensively in older solid state line extenders. In a few models a voltage variable capacitor (varicap) is found in place of the interstage capacitor. The varicap is "tuned" by a voltage derived elsewhere in the circuit by a pot.

Tilt Controls

Tilt controls are added in all line extenders so the operator in the field can adjust the tilt of each amplifier to suit the particular cable loss and flat loss conditions existing where the amplifier is installed. There are five basic ways to vary the tilt. They are discussed here in the order that they are most commonly found in the field.

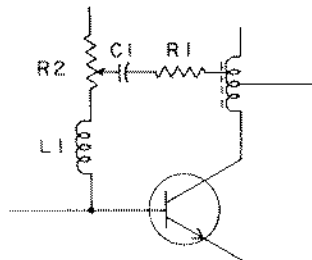

FIGURE 12

The most common utilizes an adjustable collector-base feedback to vary the low end gain of a stage. Pot R2 in figure 12 is the tilt control while resistor R1 sets the range of tile control and L1 governs the response curve of the control. C1 isolates the base voltage from the collector.

Yet another common method is to vary the emitter degeneration or current feedback as shown in figure 13. In this circuit C1 isolates the tilt network from the DC voltage on the emitter while pot R1 is the tilt control and L1 sets the response and R2 sets the range.

A very similar approach utilizes a trimmer capacitor (typically 8-50 pF) in the emitter circuit to vary the amount of emitter degeneration at the lower frequency range. As this capacitor is increased in capacity (or size), its reactance at lower frequencies is reduced, thereby creating more and more degeneration

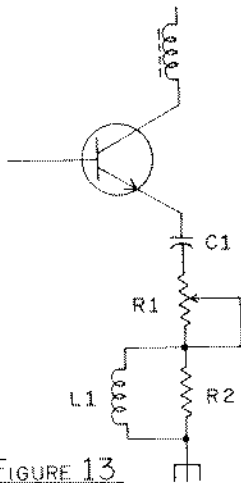

FIGURE 13

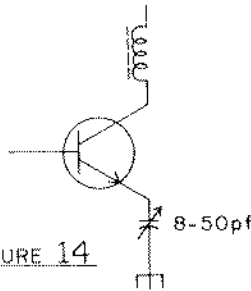

FIGURE 14

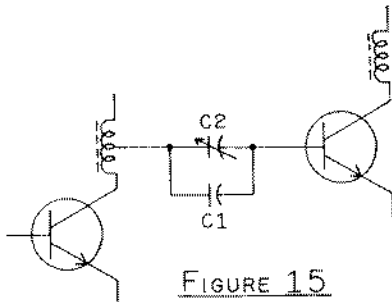

FIGURE 15

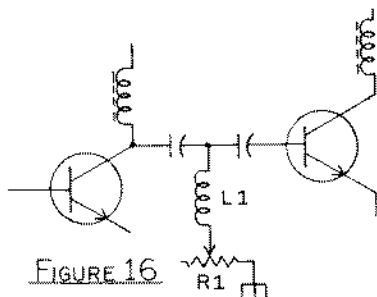

FIGURE 16

at the lower frequency end. See figure 14.

Yet another approach is to use a trimmer (adjustable capacitor) to couple two stages together. As the trimmer (C2 in figure 15) increases in value its resistance at lower frequencies *decreases* and the low end tilts up.

Finally there is the shunt method of tilt, found in figure 16. Inductor L1 retards the passage of high frequencies while the lower frequencies are shunted to ground through R1.

Briefly-Cross Modulation

In addition to flat gain, and tilt control, cross modulation is an important design consideration for a line extender. Cross modulation occurs when two or more signals are passed through *any non-linear device*. A transistor is a non-linear device. It can be controlled (but not eliminated) by proper circuit design; and the line extender design engineer wants to *control* it to the point where it does not degrade TV picture (carriers) passed through the amplifier.

Of all of the various circuits discussed here so far, a circuit with both voltage and current feedback has the best cross modulation characteristics.

The main criteria affecting cross-mod is the biasing condition of the transistor. Normally you want a fairly high Vce (collector — emitter voltage). And, to a degree, as the collector current rises, or the emitter resistors are reduced in size, the cross-mod is decreased.

Equalization

Because of the wide spectrum frequency response range of the typical solid state amplifier, and the inherent loss profile of coaxial cables, the CATV equipment designer has to compensate for a great deal of tilt in his amplifier. Keep in mind that the basic transistor has 6 db *less gain* every time the operational frequency is doubled; and, that coaxial cable losses tend to have about the same problems; i.e. *cable losses* approximately *double* every time the frequency is doubled.

To compensate for the transistor, various circuit designs already discussed are employed.

To compensate for the cable characteristics, two basic schools of engineering have

developed.

The first one says that you should build a basically *flat amplifier*. And then you should insert a passive frequency selective pad at the input of the amplifier to insure that the *amplifier input sees a flat signal*.

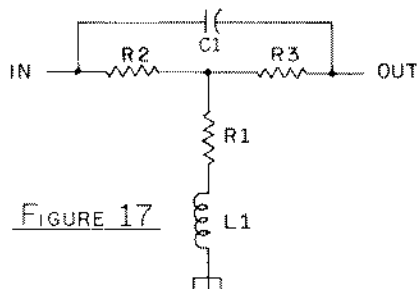

FIGURE 17

A simplified description of this form of equalization is shown in figure 17. This is a bridged-T equalizer where R2 and R3 set the impedance while C1 passes the high frequencies on to the output of the pad and R1/L1 shunt the lower frequencies to ground. The advantage to this type of equalization is greater system flexibility (plug in pad) and ease of amplifier alignment. The disadvantage is a much higher low band noise figure, associated with the shunting of the low band energy to ground.

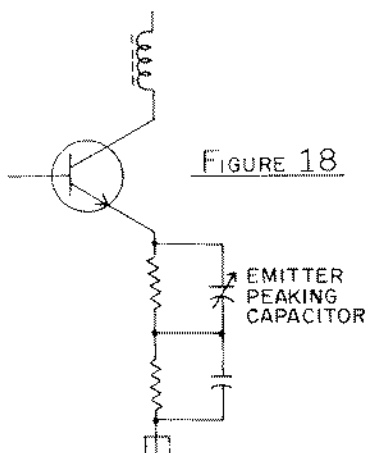

FIGURE 18

The second school of thought distributes the equalization process throughout the various stages of the amplifier. This is done by using greater amounts of feedback and raising the high end response with peaking capacitors

(see figure 18). This method has the advantage of maintaining a better low end noise figure and fewer overall amplifier stages (because of high end peaking each stage).

It has the disadvantage of taking this optional alignment or adjustment procedure out of the hands of the field installer on the pole, and it is considerably harder to align for the bench tech.

Power Supplies

The most common power supply circuit used in line extenders is the simple series regulator. The theory behind this is that the transistor will show on its emitter a voltage that is 0.7 volts lower than the voltage on the base, while current is being drawn through the collector. The base voltage is kept constant by zener diode D1 (in figure 19) while the network made up of R1 and R2 act as voltage dropping resistors. In the AC mode, the transistor is an emitter-follower, and the AC (or ripple) output will be reflective mainly of the amount of ripple on the transistor base. This is cured by adding additional filtering in the form of R1, R2 and C1.

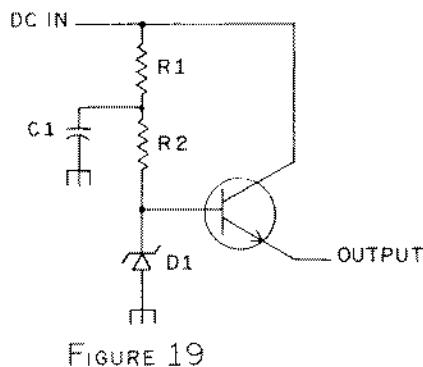

FIGURE 19

Trouble Shooting

Trouble shooting a line extender involves isolating the area of the problem, and then further isolating the component which is causing difficulty. Full trouble shooting procedures for line extenders in general and specific models in particular will be the subject of later articles here in CATJ.

Talk...

"Blue-Chip"

Signal Handling
System
with

TOCOM

... and, try your luck at winning

FREE PRIZES!

NCTA Booth 136

NEW from LRC

EMI

Integral Stainless Steel Mandrel Entry Connectors

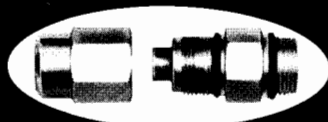

LRC introduces the new EMI cable connector for RFI Integrity. Supported with over two years field experience and 12 months RFI tests.

- Proven seals and clamping mechanism
- Large uniform contact area
- Easy installation
- Positive stop
- 6262 Aluminum for Corrosion Resistance
- In stock for Polyethylene, Polystyrene & Fused Disk Cables
- Conductive O Rings available

LRC ELECTRONICS, INC.

901 SOUTH AVE., HORSEHEADS, N.Y. 14845 PHONE 607-739-3844

Refer first to your unit schematic and the voltages shown for the various transistors. If voltages are off more than 10% from the published specs, and you are sure of your voltage measuring test equipment, the transistor should be changed out.

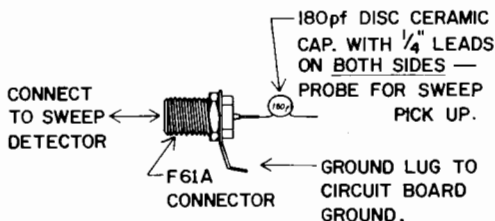

FIGURE 20

At the same time, you can and should construct a simple probe (see figure 20) and trace the signal through the unit starting at the input. Refer to this article for an explanation of what you should find at various RF points in the system.

By providing a sweep input to the defective amplifier, at the proper sweep voltage level recommended by the line extender manufacturer, you can use the probe shown in conjunction with a detector and scope display to trace the RF circuit out and check response stage by stage.

Always make sure to ground the probe (ground lug to circuit board ground) before probing. Keep in mind the function of the various feedback and equalizing networks; *don't expect flat responses throughout the amplifier!*

Taking a properly functioning line extender and the probe can be quite an educational experience and a hedge on future problems. Simply go through the unit stage by stage from the input to the output and make sketches of the response curves you see. This will be useful reference information later on should a defective unit require trouble shooting.

Once the problem area is found, check the voltages against the schematic and what is discussed here. A visual check of the suspected area will usually show up a defective resistor, scorched place on the circuit board, or a blown capacitor.

B-T MCS SERIES TUBE STRIP AMPS

One of the most utilized head end signal processing units in the earlier days of CATV and MATV was the Blonder Tongue model MCS (single channel) strip amplifier.

For its appearance on the CATV/MATV scene in the early 1950's, through its end of production in 1966, something like 30,000 units were produced and installed in off-the-air receiving systems.

Up through sometime in 1964, all of the units produced were in the MCS- (a), (b) or (c) series. Subtle changes between the units included tube change outs for newer, better tubes, changes in tuning techniques and other features that came about as technology improved.

Just before the end of the *MCS-era* in CATV/MATV strip head ends, a last version available in a package came out; the MCS-D and MCS-E strips. These strips, operated in series (diagram one), with a variable (step) attenuator between the E and D strips, had the unique feature of allowing the user to adjust his *AGC window* to the receiving conditions present at his off-the-air location.

A study by CATA this fall indicated many, many of these units still in service, however. Thus we have chosen the time honored MCS series strips for our maintenance service feature for this issue of CATJ.

Design Shortcomings

Virtually every unit of any type ever produced has a few idiosyncrasies about it. The MCS strip is no exception.

Tubes are basically high impedance devices. Consequently when *high output levels* (+60 dbmv or more) are employed, radiation becomes a very real problem. A stock single MCS strip with no outboard after-burner amplifier (such as a *BT Hot Shot*) had 45-50 db of gain from input port to output port. When two units were placed in direct series and the output of one used to feed the input of the second, the package gain became 90-100 db gain. Of course very few operators had the guts to run two in *direct series*; some form of pad was usually placed between the two units to keep the first from driving the second into sync clipping.

The MCS strips employed tube shields to cut down on direct tube-plate

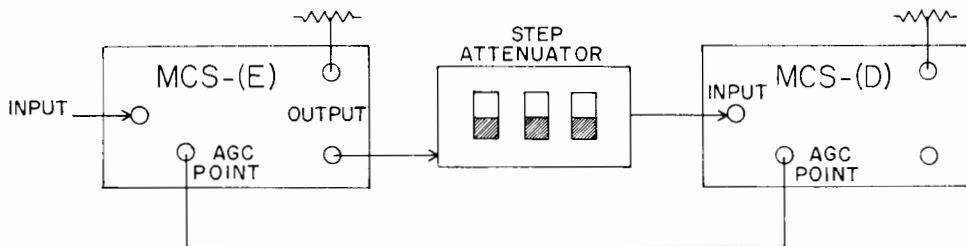

radiation; and users quickly learned that tube shields had to be in place or a feedback loop developed.

None-the-less, with the tube era came many operators who favored high level distribution starting out at the head end with outputs in the 60+ ranges, right up to the point where they started to clip sync. *Servicing MCS Units*

Most MCS series units still in service require nothing more complex than re-tubing at decent intervals. Most MCS users still use regular series tubes (6CB6, 6DJ8, etc.) although *five star* and other premium quality (PQ) tubes are still available. The difference in PQ series tubes and regular off-the-shelf tubes is one of longevity; and seemingly investing in PQ series tubes, which last longer with less deterioration, would be an intelligent thing to do.

However, as Blonder Tongue's Sam Stone told *CATJ*, "The tube manufacturers have really let quality slip in recent years, because of the emphasis on solid state devices. Because so few new equipment designs utilize tubes anymore, those companies still manufacturing tubes are not as quality conscious or competitive as they were ten or fifteen years ago." This has resulted, says Stone, in "20% of the tubes that we buy in large quantities, for repair and maintenance service, not being even useable."

Consequently, the fellow who goes into the local electronics distributor to buy some spare 6CB6's can no longer expect to simply plug-in the replacement and have his MCS strip fly like it did when it came from the factory. If nothing else, *anyone changing out tubes* in a still in service MCS strip *can expect to have to re-align the unit* with a sweep and detector. And we will show you how here.

In The Shop

We took in two MCS-C strips into the CATJ shop; both were on channel 2 and both were of the 1963-64 vintage.

One unit was fresh from operating service, and it had been re-tubed several times. Another unit was a spare, having

been pressed into service only for a day or two at a time since 1964, while the other unit was being re-tubed and checked out. The number two unit still had the original tubes in it; but total operating time was probably under 500 hours in ten years.

Both units looked about the same when swept. See photo A-1. The response curve was double peaked, around 58-59 MHz and down lower around 53-54 MHz.

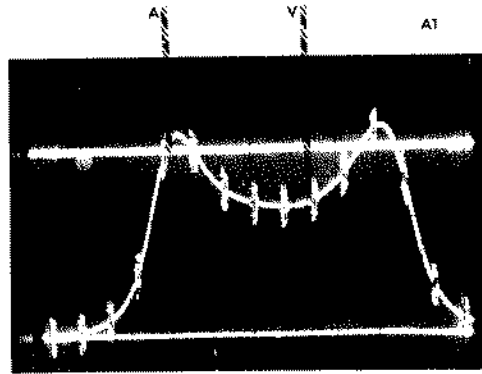

The MCS-C has a single outside user adjustment (photo 2). This slug tuned coil form is adjacent to the output SO-239 connector. We connected a +10 dbmv input signal on channel 2 to the input, rotated the gain up full and cranked on the slug tuned coil until we had peaked the video carrier output level on the FSM/SLM.

Then we re-connected the sweep and photo A-2 is what we saw, a response that ran flat from 53 to 57 MHz but began to fall off rapidly at 60 MHz. The second unit had the same results.

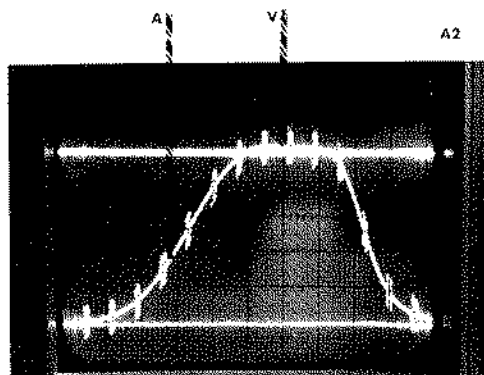

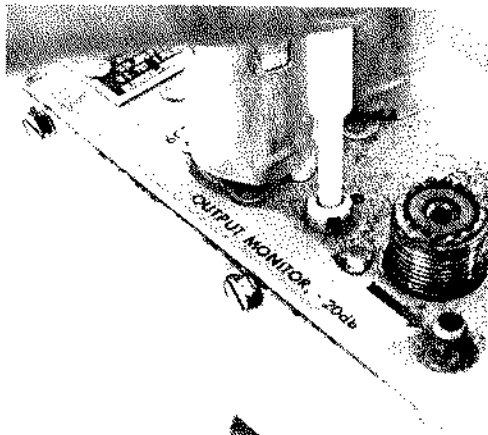

Moral? Unless you are very lucky, cranking on the only external user adjustment will probably raise the video carrier output level, but it will also roll off the gain on the color and aural end of the channel in the process. *Mark one up for sweeping the unit.*

Before we got into tube replacement and re-alignment, we sprayed some solvent (WD-40) into the gain control and AGC window pots; the gain control pot in particular was dirty and did not act linear anymore.

The unit that had seen considerable service (and numerous tube changes) was approached in this manner:

We took out each of the four tubes, one at a time, and replaced with a new pre-tested tube. We adjusted the *external slug tuned form* adjustment for best response, photographed the response curve, and then replaced the original tube and went on to the next tube repeating the process. We wanted to see what changing out a single tube at a time would do, when the tube changer only tweaked on the slug tuned coil form for readjustment. When we had done this with each of the four tubes, we pulled out the tubes and re-tubed with new, tested units, and went to work internally re-aligning the strip.

On the old but seldom used unit, we left the original tubes in place, and went inside and worked on alignment alone to try to get performance back up to something acceptable. We will follow this through

step by step here. Sweep input level is 0 dbmv gain control is set for maximum gain; *agc* set at factory mark.

6DJ8 First

The 6DJ8 was swapped first. Photo A-3 was the result. The flattest response curve we could manage had the aural end popped up; overall gain was 2.75 db greater than with the original tube in place.

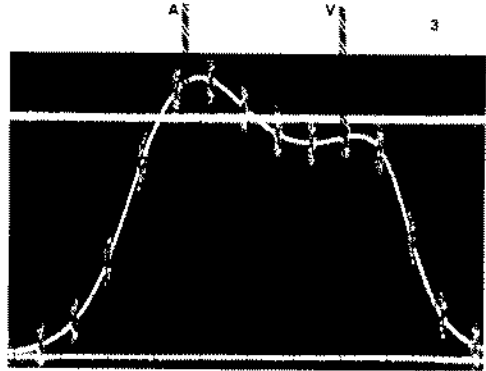

6EW6 Next

Gain with the 6EW6 swapped (6DJ8 back to original) popped up 4.5 db; however the response curve went to pot (photo A-4). Peaking with the FSM/SLM only, on the visual carrier frequency, resulted in the tilted double peaked response shown in photo A-5.

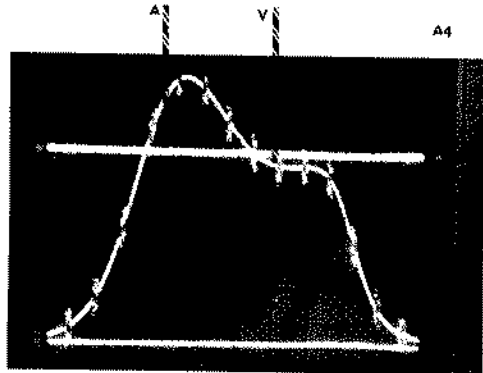

6CB6 Next

Gain with a new 6CB6 came up 1 db (all other tubes original). See photo A-6.

Peaking the externally available slug tuned form resulted in the response shown in photo A-7 (aural is down 6 db from visual).

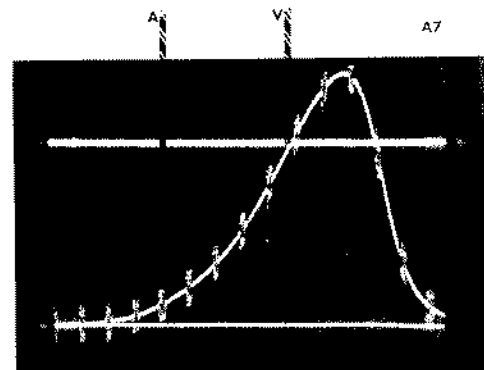
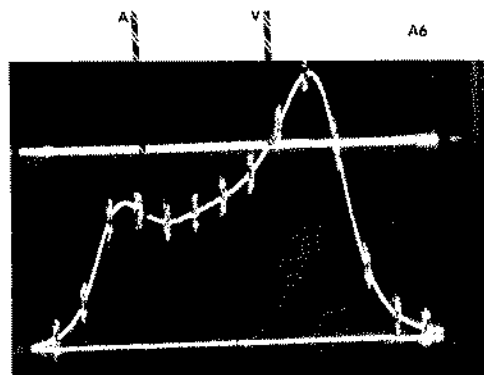
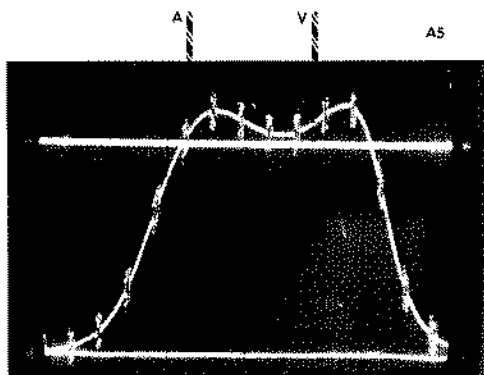

6AM8A Last

Gain with a new 6AM8A was unchanged (photo A-8). This stage is primarily the AGC function for the strip, and gain normally would not change with a change out.

14 Case Screws

There are 14 hex head metal screws that hold the side/bottom cover plate in position. All of these have to be in place, and tight, to keep radiation down.

Taking the side/bottom off has a small

effect on alignment; the gain changes slightly, but the response curve re-shapes. The way it re-shapes is a function of the alignment of the various stage and inter-stage coils, so no accurate description can be given of the cover-on cover-off responses.

Tuned circuits (i.e. those that determine bandpass and response) consist of capacitance and inductance. Capacitance can be fixed (i.e. ceramic disc) or variable (i.e. piston capacitor, mica trimmer, air variable).

Inductance can be fixed (form wound coil form, etc.), or variable (air wound coil form with variable length and turn to turn spacing).

Blonder Tongue has long been a user of variable inductances and something the design trade calls *gimmicks*. A gimmick is usually nothing more than a piece of wire, which the alignment person can move around to vary coupling (inductive or capacitive). This is sort of a sneaky way to tune a circuit, but it is inexpensive and usually stable in temperature extremes. It is hard to *calibrate* for tuning purposes, however, because you can't tell someone how to move a hunk of wire around very exactly, the doer sort of has to learn on his own.

This is part of the alignment learning-curve process required with the MCS-C; learning how to move air wound coils or wire gimmicks about until the desired response curve takes form on the sweep display screen.

For our purposes we have created our own partial schematic of those portions of the MCS-C strip which you can work with to perfect the alignment sweep curve.

Refer to diagram one. This shows the tube base diagrams for the four tubes in the unit, and the CATJ numbered inductors (some are air wound form coils and others are form coils). We have also taken the liberty of leaving out any components or signal paths not related to the basic amplification portion of the MCS-C.

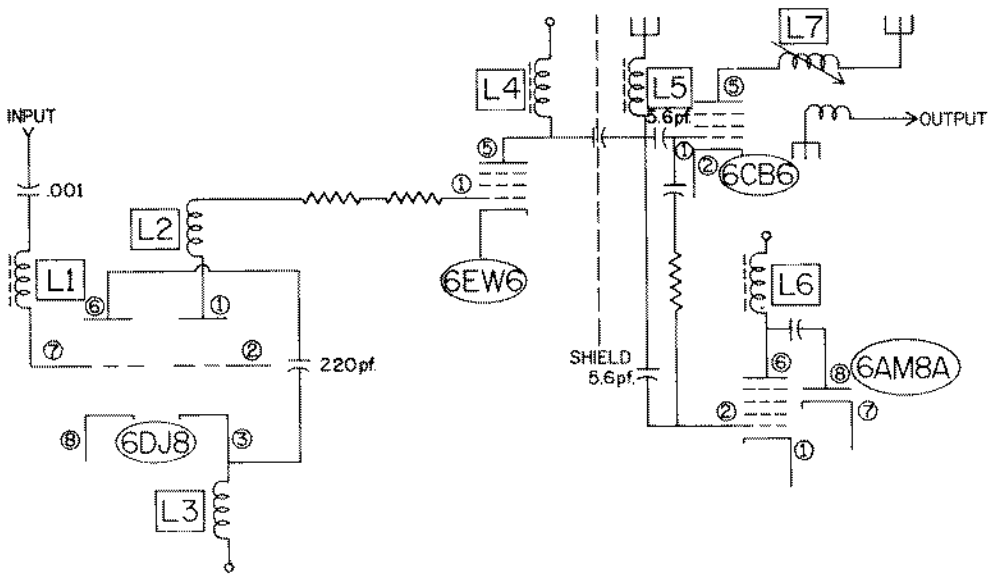

DIAGRAM ONE

Our goal is to turn out a unit that has 48-50 db of voltage gain, wide open, with flatness to ± 0.25 db within the range 55.0 to 60.0 MHz.

When we have properly tuned L1 through L6, adjustment of L7 will simply rotate the in-channel tilt around the center of the desired passband, or 57.5 MHz. That is, when L1 through L6 have been properly adjusted, adjustment of L7 will allow us to flatten out the passband over 5.0 MHz (55.0 to 60.0 MHz in this case), or, tilt it with the center (57.5 MHz) stable and move either 58-60 MHz up or down or 55-57 MHz up or down.

Start off with 0 dbmv into the unit. The output has a pair of outputs for "looping through". One of the two output chassis mounting connectors must be terminated with a 75 ohm resistor. The second output drives your sweep detector. Markers at 54 and 60 MHz, or every MHz, or at 55.25 and 59.75 MHz are important so you know where you are within the design channel (channel 2 examples given).

L1, L2, L4 and L5 are the most responsive inductors in the package, in addition

to L7. L3 and L6 have marginal affects.

Typically, the following will happen:

(1) Pushing the turns of L1 closer together, on the form, increases gain on the mid to low end. Spreading the turns apart increases the gain on the high end.

(2) L2 (air wound coil) — must be *re-shaped* to change the bandpass response. Lifting up in the center (i.e. grasping center of coil with plastic tool and lift up, forming an upside down letter "V") causes gain to increase on the high end of the channel; pushing down lowers the high end gain.

(3) L4 (form wound coil) is adjusted by varying the turn to turn spacing and by moving the coil turns as a group along the form. For example, pushing the coils as a



group down, towards pin 5 on the 6EW6, peaks the low end of the channel; pushing towards the tie point end of the coil mount peaks the high end.

(4) L5 (form wound coil) mounts between two tie points on a terminal strip. Pushing the coil along the form, towards either extreme (end) will decrease the response on the low end of the channel. Placed in the center of the form and spread (i.e. re-spread) evenly balances the gain over the full channel.

(5) L6 (on pin 6 of the 6AM8A) is a vertically mounted form wound coil, suspended on the top end by a tie point.

If the channel response is too wide (i.e. extending beyond 55-60 MHz), push 1, 2 or 3 turns of the coil down off of the form towards the 6th pin of the tube socket.

The correct bandpass response for the units worked-over (a channel 2 unit) is shown in photo A-9. The package gain works out to 48-50 db with 0 dbmv input; 54.5 to 60.5 MHz. ± 0.25 db.

Please note that the purpose of this article is to acquaint anyone with an

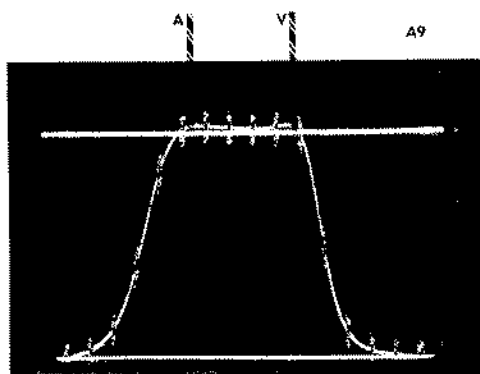

MCS-C on their hands and in need of service with a few basic facts:

(1) Changing out tubes will surely change the bandpass response, perhaps causing added gain but also probably peaking the response curve someplace in or outside of the desired bandwidth.

(2) Torquing on L7 (the only user accessible adjustment without lifting the cover) will only improve the bandpass response if all of the other coil adjustments (L1-L6) are properly tuned; and probably never will adequately compen-

GEORGE MILNER

4951 Titan Way, Denver, Colorado 80239 (303) 373-4596

Although "Mini-Proof II" explains the use of sweep generators, scopes and spectrum analyzers, your proof CAN be accomplished with the same test equipment which was used for "Mini-Proof I".

You will do your 1974 Proof of Performance quicker, easier and more thoroughly by using these time proven procedures and forms.

All "Mini-Proofs" are interpreted and completed by Geo. Milner. All information goes into a concise report which follows the instructions of the Federal Communications Commission's Rules.

Any technician, new or old timer, will better understand his cable system after working with George on this basic, down to earth method.

There are some LABOR SAVING tricks which cannot be taken advantage of unless you get an early start. Order your "Mini-Proof II" today, so that we will have all summer to work on it.

ONLY \$100. PER SYSTEM

CATV SYSTEMS

MICROWAVE SYSTEMS

TECHNICAL SERVICE

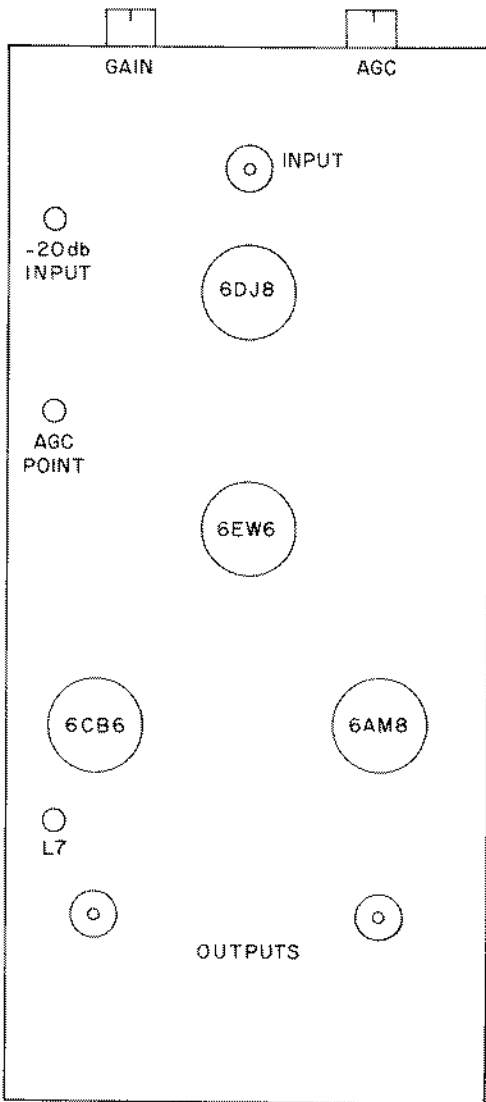

sate for a tube change out.

Tuning L7 with an FSM/SLM will only result in a peaked response at the point within the passband where you have the FSM/SLM tuned (i.e. video carrier or audio carrier).

(3) Tuning of L1-L6 (as marked in this article) will produce the desired bandpass you are after, but there is considerable jockeying back and forth required to get the right mixture. This should *never* be attempted with an FSM/SLM only.

Stamp Out Postage Waste On Customer Bills... Before It Stamps You Out!

(At 10¢ a throw you can't afford it.)

EXAMPLE:

	BILLS PER CUST./YR.		POSTAGE	TOTAL
A*	12	X	\$.10	= \$1.20
B*	1	X	.10	= .10
SAVINGS PER CUSTOMER				= \$1.10

*B-Coupon Bills; A-All Other Types of Billing

Multiply the number of your customers by the bottom line figure to determine total postage savings with coupon books. That savings can appear on your company's bottom line as additional profit. Think about that!

And, remember: one book of 12-monthly coupons means one bill, one postage charge for a customer for a whole year; cuts postage costs by as much as 92%.

Send today for catalog containing prices and ordering information.

T-C SPECIALTIES CO.

Coudersport, Pa. 16915
Phone: (814) 274-8060

COUPON BILLING SPECIALISTS

JERRY CONN & ASSOCIATES

NATIONAL REPRESENTATIVES OF
DELTA - BENCO - CASCADE

TO THE CATV & MATV INDUSTRIES

• Nationwide Wats
(800) 233-0940

• In PA. Call Collect
(717) 263-8258

550 Cleveland Avenue
Chambersburg, Pa. 17201

FOR SALE

Completely new, universal spare signal processor. One unit provides a standby spare for any on channel signal processor. Output 55dbmv, Adj. channel rejection 55db, noise figure 6db, AGC 40 db, Gain 70db standby carrier. Available for converted channels also \$500.00 complete, \$25.00 extra for each converted channel.

CALL OR WRITE
RICHEY DEVELOPMENT

7242 W. Reno, Rt. 5
Oklahoma City, Oklahoma 73108
(405) 787-5086

Economical New Weather-Scan III

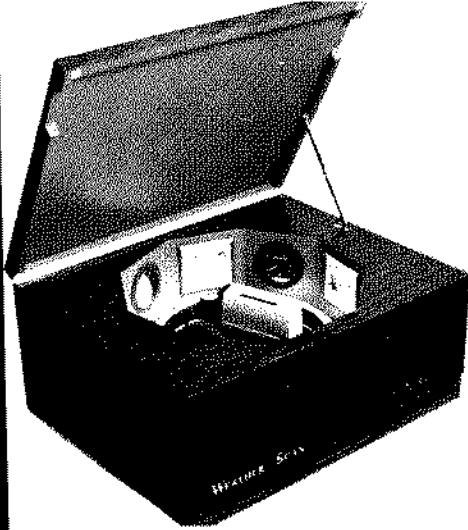

New, compact time-weather unit from the originators of the time-weather format. Compact (14 inches high x 28 inches wide x 23 inches deep) and low cost (\$1595.00*) . . . this is the perfect small-system package.

Time, temperature, barometric pressure, wind velocity, wind direction and four (4!) card display spots with a Sony AVC-1400 (2:1 interlace) camera. Unit features unidirectional clockwise-scanning sequence and is designed for long term, 24 hour per day usage and a minimum of maintenance.

*—Deluxe model with Texas Electronics instruments available at additional cost.

Weather Scan

Loop 132—Throckmorton Hwy.

Olney, Texas 76374

Phone 817-564-5688

Voltages

Typical voltages for the various tube socket pins, tie points and AGC and gain control pots are given in the tables.

Power supply filtering problems are usually caused by excessive heat (remember this is tube equipment); experienced users tell CATJ that the can type capacitor (100 MFD at 200 volts and 80 MFD at 200 volts) usually goes first, followed by one or both of the paper electrolytics (45 MFD at 175 volts). A hum bar in the picture (bad filtering) can usually be traced to the can type capacitor.

Voltages - Table One

6DJ8 (*)	Gain Max	Gain Min
Pin 1	+40 vdc	+62 vdc
Pin 2	-75 vdc	-75 vdc
Pin 3	-75 vdc	-75 vdc
Pin 4	filament	
Pin 5	filament	
Pin 6	+82 vdc	+130 vdc
Pin 7	+50 vdc	+55 vdc

(* or 6ES8, 6922)

6EW6	Gain Max	Gain Min
Pin 1	+0.35 vdc	+0.55 vdc
Pin 2	+1.25 vdc	+5.50 vdc
Pin 3	filament	
Pin 4	filament	
Pin 5	+125 vdc	+145 vdc
Pin 6	+125 vdc	+145 vdc
Pin 7	no DC voltage	

6CB6	Gain Max	Gain Min
Pin 1	-140 vdc	-140 vdc
Pin 2	-140 vdc	-140 vdc
Pin 3	filament	
Pin 4	filament	
Pin 5	no dc voltage	
Pin 6	no dc voltage	
Pin 7	-140 vdc	-140 vdc

6AM8/

6AM8A	Gain Max	Gain Min
Pin 1	+40 vdc	+65 vdc
Pin 2	VTVM measurement	
Pin 3	+120 vdc	+145 vdc
Pin 4	filament	
Pin 5	filament	
Pin 6	+120 vdc	+145 vdc
Pin 7	+45 vdc	+75 vdc
Pin 8	VTVM measurement	
Pin 9	VTVM measurement	

CABLE BUREAU COMMUNIQUE

Not very long ago the Cable Television Bureau was divided into branches, much as other bureaus had done in years past.

To insiders the division along branch lines was a healthy sign that the Cable Bureau staff was stabilizing and that the emphasis was about to swing from policy making to policy implementation on a day to day and week to week basis.

Of course **policy making** is not over; a number of important matters still remain to be resolved. At some point it was necessary for the Cable Bureau to add skilled personnel to their staff who would dedicate their working days to guiding the regulatees (the CATV systems) through the applicable sections of Part 76.

One of these new branches is called the **Special Relief and Enforcement Branch**. It is headed by a personable young attorney named Tony Cavender. System operators in Arkansas, Oklahoma, Mississippi, Texas, and Louisiana met with him in June of last year during the first three Small System Operator/Cable Bureau Meetings, held in Little Rock, Jackson and Austin.

The Special Relief and Enforcement Branch (SREB) has a very special activity area for all system operators, one that has gone virtually unnoticed by the industry to date. That area of interest is **signal carriage exclusivity** and **non-duplication protection**. While not always said in the same breath, they go hand in hand with one another.

Basically, the Rules provide (76.91) that stations shall be afforded, under certain circumstances, "protection" against the encroachment of same network, same release time parallel-programming from other stations which a CATV system might carry.

The rules also provide (76.151) that CATV systems operating within the top 50 markets shall provide syndicated program (ie, non-network fare) exclusivity under certain circumstances.

It is the enforcement of program exclusivity which causes CATV systems to **provide non-duplication protection**; and, as many system operators are aware, it is non-duplication protection which gives systems of all sizes one of the most difficult public relation problems faced on a day to day basis.

At the present time, CATV systems serving fewer than 500 subscribers are exempt from the requirement that they provide non-duplication

protection. Seemingly, then, systems of fewer than 500 subscribers would have few matters to discuss with the SREB. This is not altogether true.

While a good portion of the time and effort of the SREB is spent on working out problems exclusivity, there is also time available for conflicts between CATV system operators and television broadcasters in the matter of **mandatory carriage**.

Mandatory carriage means that a CATV system is located within the predicted Grade B contour of a television station, and because of this physical circumstance, the CATV system must (by FCC Rule) carry the signal of the station. At the same time, a CATV system must also carry the signal of any station which is significantly viewed in the county in which the CATV system is located (76.54). That is where a conflict often arises. Very often the terrain (topography) in an area eliminates direct viewing (on or off the cable) of signals which are supposed to be placing a Grade B (or even Grade A) contour over the community. In a situation like this, the nice round Grade B contour drawn by the TV station's engineers goes over a county or area where people cannot view the signal. If a town located in this region has a CATV system, and the CATV system is also unable to pick up the signal of the TV station in question then usually the CATV system must go someplace else to find a station of the same network as the unavailable signal so that system viewers have a full choice of all three networks. This usually irks the station with the nice round Grade B contour, but no coverage.

According to the rules, a TV station has the right to request carriage by a CATV system, if the CATV system is located within the Grade A or B contours. According to the Rules, the CATV system must comply and carry the station.

Suppose the CATV system truly cannot pick up the signal of the TV station. **Then what?**

As things now stand, the TV station can file a complaint with the Cable Bureau. In filing such a complaint, the TV station invariably maintains that it is placing a good signal (or useable signal) over the CATV community (or head end). Based upon this allegation, along with the fact that the CATV system is not carrying the station, the Cable Bureau notifies the CATV system of the TV station complaint and allows the CATV system 30 days to respond. Often in the response the CATV

system sets out its own facts including its contention that the TV station is not **viewable**, Grade B (or A) contour or not.

Then the Cable Bureau allows the TV station 20 additional days to file a reply to the CATV system's filing.

At that point the entire matter goes before the Cable Bureau personnel where it is studied. Based upon what the Bureau sees in the original complaint, the CATV system reply and the TV station response, then the Cable Bureau can send the entire matter up to the full Commission with a recommendation that it do one of four things:

(1) the CATV system should comply with the TV station's request,

(2) the TV station has no case and the request for compliance against the CATV system should be dropped,

(3) the facts around the situation suggest a waiver in the rules,

(4) the facts surrounding the case are not clear-cut and a hearing should be scheduled by the full Commission.

Of course the seven Commissioners are not bound by the Cable Bureau recommendations; they can do as the Cable Bureau recommends, or they can strike out on their own and do something entirely different.

From the time the initial complaint is filed by the TV station until the matter is sent to the full Commission, it is now handled by Mr. Cavender and his group, the SREB.

Those who know Tony Cavender believe him to be a fair minded, intelligent man with more than a passing feel for the problems of the small system operator. Tony remembers his June 1973 trip through the South and Southwest and his visit to a CATV system in Mississippi while on his **tour of duty**. He remembers too example after example brought to his attention while on that trip which indicated that all too often a CATV system was being forced to eliminate the programs of NBC affiliate "A" in favor of NBC affiliate "B", simply because some engineer many years ago had drawn a circle around a TV transmitting tower and proclaimed "everything inside of that circle is ours".

The SREB office has recently taken steps to help speed the decision process in cases of carriage compliance, and to make things a little easier on the CATV system operator called upon to **defend** his choice of TV stations he is carrying (or wishes to).

Cavender notes one of the sticky points is the question of "**Is there a signal there?**" The TV station invariably say "yes". The CATV system invariably says either "no", or "yes, but it is of very

poor quality".

The TV station backs up its contention that a signal is there with a statement from its engineer and/or a consulting engineer. The CATV system can either try to counter the TV station claim with a statement of **its engineer**, or the CATV system can hire its own consultant.

Because most CATV systems feel they must present the strongest argument possible to counteract the TV station "facts", this often means an expensive consultant for the CATV system. As Cavender notes, "this still leaves SREB and the Commission in the dark because we now have one consultant saying **yes** and one consultant saying **no**."

So Cavender has begun a series of meetings with personnel from the Commission's **Field Engineering Bureau (FEB)**, the people who man offices from coast to coast performing inspections of broadcast facilities and who one day will also be inspecting CATV facilities.

The plan is to set up a program whereby SREB can call on the FEB to make the measurements so that we, in turn, will have the information we require to send our recommendation to the full Commission.

With every great plan there is at least one flaw. In this case it is **method of measurement**. The CATV industry uses one method; the television broadcasters favor another method. Still others are favored by dissident engineers in both groups.

One of the side benefits of this program is that when it goes into effect, the smaller systems, who today often feel victimized by the television broadcasters because they cannot afford the services of a consulting engineer to make their reply measurements, will be able to count on the services of the FEB.

Cavender admits to being "not much of an engineering mind" and, for an attorney saddled with having to referee feuds between two different engineering technologies, he is looking forward to being able to lean on FEB to give him the expertise he feels the Cable Bureau (and the Commission) must have to reach fair decisions in matters such as these.

Cavender notes, "the 1972 Rules probably placed hundreds of communities in situations where, if the rules are adhered to strictly and without waivers, people are going to be deprived of the best quality television that CATV is capable of delivering. We want to focus on these situations and clear them up so that the full potential of CATV can be realized."

NEED SREB ASSISTANCE? You can reach the Special Relief and Enforcement branch at (202) 632-9703.

Warranty

All connectors conform to the electrical, mechanical and environmental characteristics stated in our Engineering Report of December 4, 1972. Our obligation under this warranty is limited to connector and labor costs of replacing any connector which may prove defective one year from date of shipment per trim instruction.



SuperWarranty

We have enough faith in our products, our people and our customers to put it in writing. Not just a warranty, but a written performance guarantee. The only one in the industry. When you buy the SuperConnector, the SuperWarranty comes with it, for no additional charge.

We tell you what you can expect and guarantee that you'll get it.

We think this is the way everybody should do business. Someday maybe everyone will. Meanwhile, isn't it nice to know that somebody thinks enough of their product to put it in writing?

We also say this: *You can pay a lot more for your connectors. You can't buy a better connector.*

Cambridge. The SuperConnector.

Cambridge Products

101 Foley St., Somerville, Mass. 02145, (617) 666-3343
Atlanta, Ga. • Simi Valley Calif. • Toronto, Canada
In Europe: H-G D'Italia • Cisterna Di Latina, Italy
A subsidiary of Cambridge Screw Company, a H-G Company.

YOU GET WHAT YOU PAY FOR!

With Dolphin's DT-5500 here's what you pay for:

1. Cadmium plating for high corrosion resistance and silver impregnated silicone gasketing for virtually perfect weather proofing and exceptional R.F.I. protection.
2. Versatility. It can be used for both aerial and underground installations, and it's small enough to fit into a four inch pedestal.
3. Superior circuitry. We'll be happy to send you a set of specs and some comparative testing data.
4. Uncommonly neat engineering features like ferrite beads to replace tuning coils, captive screws and die cast "F" fittings for additional moisture proofing and a continuous electrical ground.

And here's what you get:

Decreased maintenance costs, simplified installations, elimination of multiple parts stocking, and most important, improved service to your subscribers.

For the best connections in cable television.

dolphin **cl**
CABLE TELEVISION EQUIPMENT

